

DLPT™ PROJECTOR

MODEL

HD1000

User Manual

HDMI™
HIGH-DEFINITION MULTIMEDIA INTERFACE

HD
ready

HD 1000

This User Manual is important to you.
Please read it before using your projector.

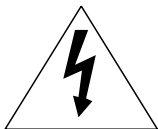
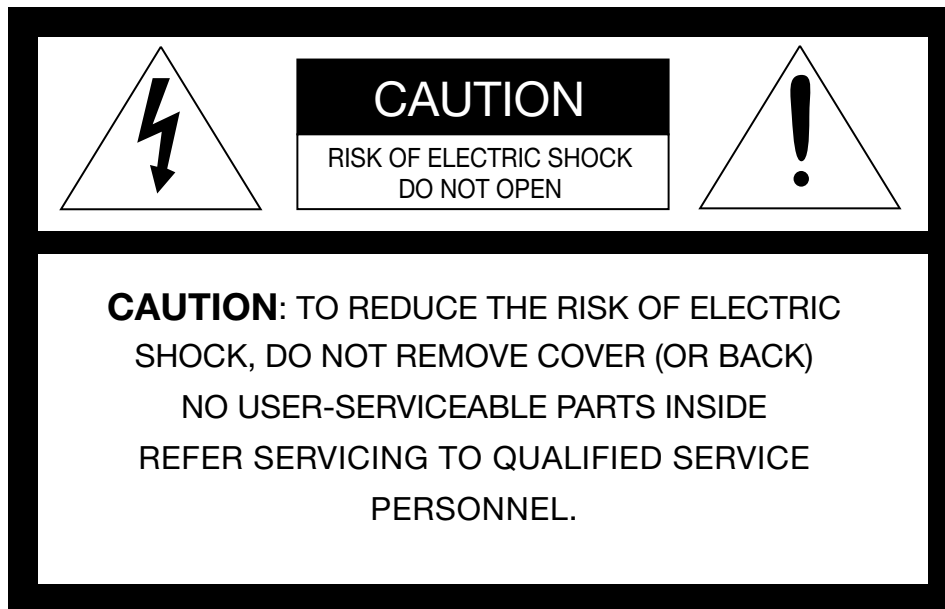

The lightning flash with arrowhead symbol within an equilateral triangle is intended to alert the user to the presence of uninsulated “dangerous voltage” within the product’s enclosure that may be of sufficient magnitude to constitute a risk of electric shock.



The exclamation point within an equilateral triangle is intended to alert the user to the presence of important operating and maintenance (servicing) instructions in the literature accompanying the appliance.

WARNING:

TO PREVENT FIRE OR SHOCK HAZARD, DO NOT EXPOSE THIS APPLIANCE TO RAIN OR MOISTURE.

CAUTION:

TO PREVENT ELECTRIC SHOCK, DO NOT USE THIS (POLARIZED) PLUG WITH AN EXTENSION CORD, RECEPTACLE OR OTHER OUTLET UNLESS THE BLADES CAN BE FULLY INSERTED TO PREVENT BLADE EXPOSURE.

NOTE:

SINCE THIS PROJECTOR IS PLUGGABLE EQUIPMENT, THE SOCKET-OUTLET SHALL BE INSTALLED NEAR THE EQUIPMENT AND SHALL BE EASILY ACCESSIBLE.

WARNING

Use the attached specified power supply cord. If you use another power supply cord, it may cause interference with radio and television reception.

Use the attached RGB cable and RS-232C cable with this equipment so as to keep interference within the limit of a FCC Class B device.

This apparatus must be grounded.

DO NOT LOOK DIRECTLY INTO THE LENS WHEN THE PROJECTOR IS IN THE POWER ON MODE.

CAUTION

Not for use in a computer room as defined in the Standard for the Protection of Electronic Computer/ Data Processing Equipment, ANSI/NFPA 75.

When using the projector in Europe:

COMPLIANCE NOTICE

This Projector complies with the requirements of the EC Directive 89/336/EEC “EMC Directive” as amended by Directive 92/31/EEC and 93/68/EEC, and 73/23/EEC “Low Voltage Directive” as amended by Directive 93/68/EEC.

The electro-magnetic susceptibility has been chosen at a level that gains proper operation in residential areas, on business and light industrial premises and on small-scale enterprises, inside as well as outside of the buildings. All places of operation are characterised by their connection to the public low voltage power supply system.

WARNING

Use the attached RGB cable and RS-232C cable with this equipment so as to keep interference within the limits of an EN55022 Class B device. Please follow WARNING instructions.

Contents

Important safeguards	4
Preparing your projector.....	6
Using the remote control.....	9
Setting up your projector.....	10
Viewing video images.....	13
Viewing computer images	20
Menu operation	23
Adjusting projected images.....	27
Advanced features	30
Replacing the lamp	31
Troubleshooting.....	33
Indicators.....	36
Specifications.....	37



Note: This symbol mark is for EU countries only.
 This symbol mark is according to the directive 2002/96/EC Article 10
 Information for users and Annex IV.

Your MITSUBISHI ELECTRIC product is designed and manufactured with high quality materials and components which can be recycled and reused.

This symbol means that electrical and electronic equipment, at their end-of-life, should be disposed of separately from your household waste.

Please, dispose of this equipment at your local community waste collection/recycling centre.

In the European Union there are separate collection systems for used electrical and electronic product.

Please, help us to conserve the environment we live in!

Declaration of Conformity

Model number: HD1000
 Trade name: MITSUBISHI ELECTRIC
 Responsible party: Mitsubishi Digital Electronics America, Inc.
 9351 Jeronimo Road, Irvine, CA 92618 U.S.A
 Telephone number: +1-(949) 465-6000

This device complies with Part 15 of the FCC Rules. Operation is subject to the following two conditions:
 (1) this device may not cause harmful interference, and
 (2) this device must accept any interference received, including interference that may cause undesired operation.

Trademark, Registered trademark

Macintosh is registered trademark of Apple Computer Inc.

DLP™, Digital Micromirror Device, DMD and BrilliantColor™ are all trademarks of Texas Instruments.

HDMI, the HDMI logo and High-Definition Multimedia Interface are trademarks or registered trademarks of HDMI Licensing LLC.

The “HD ready” logo is a trademark of EICTA.

Other brand or product names are trademarks or registered trademarks of their respective holders.

Important safeguards

Please read all these instructions regarding your projector and retain them for future reference. Follow all warnings and instructions marked on the projector.

1. Read instructions
All the safety and operating instructions should be read before the appliance is operated.
2. Retain instructions
The safety and operating instructions should be retained for future reference.
3. Warnings
All warnings on the appliance and in the operating instructions should be adhered to.
4. Instructions
All operating instructions must be followed.
5. Cleaning
Unplug this projector from the wall outlet before cleaning it. Do not use liquid aerosol cleaners. Use a damp soft cloth for cleaning.
6. Attachments and equipment
Never add any attachments and/or equipment without the approval of the manufacturer as such additions may result in the risk of fire, electric shock or other personal injury.
7. Water and moisture
Do not use this projector near water or in contact with water.
8. Accessories
Do not place this projector on an unstable cart, stand, tripod, bracket or table. Use only with a cart, stand, tripod, bracket, or table recommended by the manufacturer or sold with the projector. Any mounting of the appliance should follow the manufacturer's instructions and should use a mounting accessory recommended by the manufacturer.



An appliance and cart combination should be moved with care. Quick stops, excessive force and uneven surfaces may cause the appliance and cart combination to overturn.

9. Ventilation
Slots and openings in the cabinet are provided for ventilation, ensuring reliable operation of the projector and to protect it from overheating. Do not block these openings or allow them to be blocked by placing the projector on a bed, sofa, rug, or bookcase. Ensure that there is adequate ventilation and that the manufacturer's instructions have been adhered to.

10. Power sources
This projector should be operated only from the type of power source indicated on the marking label. If you are not sure of the type of power, please consult your appliance dealer or local power company.
11. Power-cord protection
Power-supply cords should be routed so that they are not likely to be walked on or pinched by items placed upon or against them. Pay particular attention to cords at plugs, convenience receptacles, and points where they exit from the appliance. Do not put the power cord under a carpet.
12. Overloading
Do not overload wall outlets and extension cords as this can result in a fire or electric shock.
13. Objects and liquids
Never push objects of any kind through openings of this projector as they may touch dangerous voltage points or short-out parts that could result in a fire or electric shock. Never spill liquid of any kind on the projector.
14. Servicing
Do not attempt to service this projector by yourself. Refer all servicing to qualified service personnel.
15. Damage requiring service
Unplug this projector from the wall outlet and refer servicing to qualified service personnel under the following conditions:
 - (a) If the power-supply cord or plug is damaged.
 - (b) If liquid has been spilled, or objects have fallen into the projector.
 - (c) If the projector does not operate normally after you follow the operating instructions. Adjust only those controls that are covered by the operating instructions. An improper adjustment of other controls may result in damage and may often require extensive work by a qualified technician to restore the projector to its normal operation.
 - (d) If the projector has been exposed to rain or water.
 - (e) If the projector has been dropped or the cabinet has been damaged.
 - (f) If the projector exhibits a distinct change in performance - this indicates a need for service.
16. Replacement parts
When replacement parts are required, be sure that the service technician has used replacement parts specified by the manufacturer or parts having the same characteristics as the original part. Unauthorized substitutions may result in fire, electric shock or other hazards.
17. Safety check
Upon completion of any service or repair to this projector, ask the service technician to perform safety checks determining that the projector is in a safe operating condition.

WARNING:**Unplug immediately if there is something wrong with your projector.**

Do not operate if smoke, strange noise or odor comes out of your projector. It might cause fire or electric shock. In this case, unplug immediately and contact your dealer.

Never remove the cabinet.

This projector contains high voltage circuitry. An inadvertent contact may result in an electric shock. Except as specifically explained in the User Manual do not attempt to service this product by yourself. Please contact your dealer when you want to fix, adjust or inspect the projector.

Do not modify this equipment.

It can lead to fire or electric shock.

Do not keep using the damaged projector.

If the projector is dropped and the cabinet is damaged, unplug the projector and contact your dealer for inspection. It may lead to fire if you keep using the damaged projector.

Do not face the projector lens to the sun.

It can lead to fire.

Use correct voltage.

If you use incorrect voltage, it can lead to fire.

Do not place the projector on uneven surface.

Place the projection on a leveled and stable surface only. Please do not place equipment on unstable surfaces.

Do not look into the lens when it is operating.

It may hurt your eyes. Never let children look into the lens when it is on.

Do not unplug the power cord during operation.

It can lead to lamp breakage, fire, electric shock or other trouble. It is best to wait for the fan to turn off before turning the main power off.

Do not touch the air outlet grille and bottom plate, which become hot.

Do not touch them or put other equipment in front of the air outlet grille. The air outlet grille and bottom

plate, when heated, may cause injury or damage to other equipment. Also, do not set the projector on the desk which is easily affected by heat.

Do not look into the air outlet grille when projector is operating.

Heat, dust, etc. may blow out of it and hurt your eyes.

Do not block the air inlet and outlet grilles.

If they are blocked, heat may be generated inside the projector, causing deterioration in the projector quality and fire.

Do not use flammable solvents (benzene, thinner, etc.) and flammable aerosols near the projector.

Flammable substances may ignite causing fire or breakdown because the temperature inside the projector rises very high while the lamp is illuminating.

Place of installation

For safety's sake, refrain from setting the projector at any place subjected to high temperature and high humidity. Please maintain an operating temperature, humidity, and altitude as specified below.

- Operating temperature: between +41°F (+5°C) and +95°F (+35°C)
- Operating humidity: between 30% and 90%
- Never put any heat-producing device under the projector so that the projector does not overheat.
- Do not attach the projector to a place that is unstable or subjected to vibration.
- Do not install the projector near any equipment that produces a strong magnetic field. Also refrain from installing near the projector any cable carrying a large current.
- Place the projector on a solid, vibration free surface; otherwise it may fall, causing serious injury to a child or adult, and serious damage to the product.
- Do not stand the projector; it may fall, causing serious injury and damage to the projector.
- Slanting the projector more than $\pm 10^\circ$ (right and left) or $\pm 15^\circ$ (front and rear) may cause trouble or explosion of the lamp.
- Do not place the projector near air-conditioning unit or heater to avoid hot air to the exhaust and ventilation hole of the projector.

COMPLIANCE NOTICE OF FCC

This equipment has been tested and found to comply with the limits for a Class B digital device, pursuant to Part 15 of the FCC Rules. These limits are designed to provide reasonable protection against harmful interference in a residential installation. This equipment generates, uses and can radiate radio frequency energy and, if not installed and used in accordance with the instructions, may cause harmful interference to radio communications. However, there is no guarantee that interference will not occur in a particular installation. If this equipment does cause harmful interference to radio or television reception, which can be determined by turning the equipment off and on, the user is encouraged to try to correct the interference by one or more of the following measures:

- Reorient or relocate the receiving antenna.
- Increase the separation between the equipment and receiver.
- Connect the equipment into an outlet on a circuit different from that to which the receiver is connected.
- Consult the dealer or an experienced Radio/TV technician for help.

Changes or modifications not expressly approved by Mitsubishi could void the user's authority to operate this equipment.





COMPLIANCE NOTICE OF INDUSTRY CANADA

This Class B digital apparatus complies with Canadian ICES-003.

Preparing your projector

Checking accessories

The following accessories are provided with this projector. Check to be sure that all of the accessories are packed in the package.

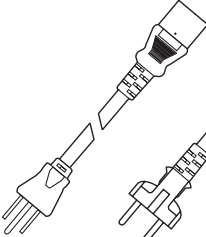
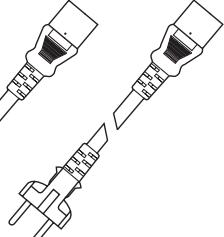
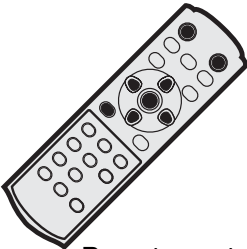
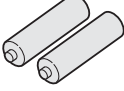
<p>■ Cables</p>  <p>Mini D-SUB 15-pin</p>  <p>Mini D-SUB 15-pin</p> <p>RGB cable for PC (246C521-10)</p>	 <p>D-SUB 9-pin</p>  <p>8-pin</p> <p>RS-232C cable (246C508-10)</p> <ul style="list-style-type: none">• Used for projector control by computer.	<p>■ Power supply parts</p>   <p>Power cord (two) (246C483-10, 246C383-20)</p>
<p>■ Remote control parts</p>  <p>Remote control (290P133-30)</p>  <p>R03 (Size-AAA) battery (two)</p>	<p>■ Others</p> <ul style="list-style-type: none">• Lens cap (Attached to the projector)• User manual/Quick Start up (English only) (871D423-80)• CD-ROM (with User manual) (919C137-90)• Safety manual/Quick Start up (871D421-90)	

Important:

- The attached power cords are to be used exclusively for this product. Never use them for other products.

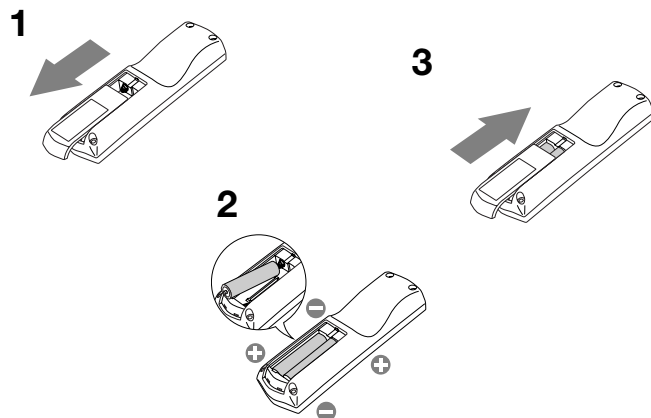

Inserting the batteries into the remote control

1. Remove the back lid of the remote control.
2. Check the polarity (+), (-) of the batteries, and set them correctly, inserting their (-) side first.
 - If the battery is inserted from the (+) side first, inserting the (-) side is difficult because the coil spring end hits on the battery side. If the battery is forced in this way, the outer label of the battery may get ripped and it may cause a short-circuit and heating.
3. Attach the back lid.

Important:

- Use two size-AAA batteries (R03).
- Replace the two batteries with new ones when the remote control is slow to respond.

Caution:

- Use of a battery of wrong type may cause explosion.
- Only Carbon-Zinc or Alkaline-Manganese Dioxide type batteries should be used.
- Dispose of used batteries according to your local regulations.
- Batteries may explode if misused. Do not recharge, disassemble, or throw them in fire.
- Be sure to handle the batteries according to the instructions.
- Load the batteries with its positive (+) and negative (-) sides correctly oriented as indicated on the remote control.
- Keep batteries out of reach of children and pets.
- Remove the batteries, if the remote control is not used for a long time.
- Do not combine a new battery with an old one.
- If the solution of batteries comes in contact with your skin or clothes, rinse with water. If the solution comes in contact with your eyes, rinse them with water and then consult your doctor.

Overview

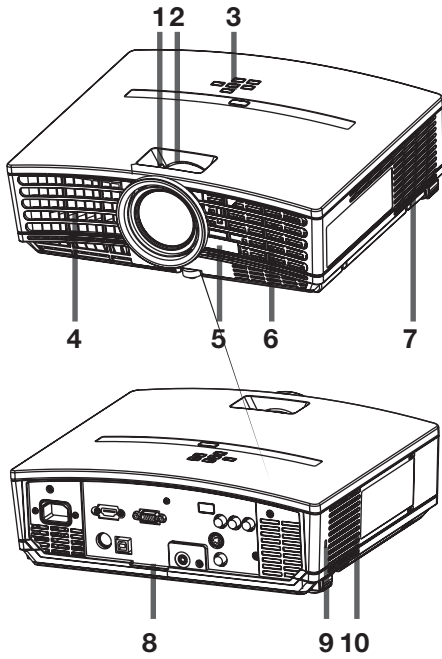

- 1 FOCUS ring
- 2 ZOOM ring
- 3 Control panel
- 4 Air outlet grille
- 5 Remote control sensor (Front)
- 6 Air inlet grille
- 7 Air outlet grille
- 8 Terminal board
- 9 Kensington Security Lock Standard connector
- 10 Air inlet grille

Control area

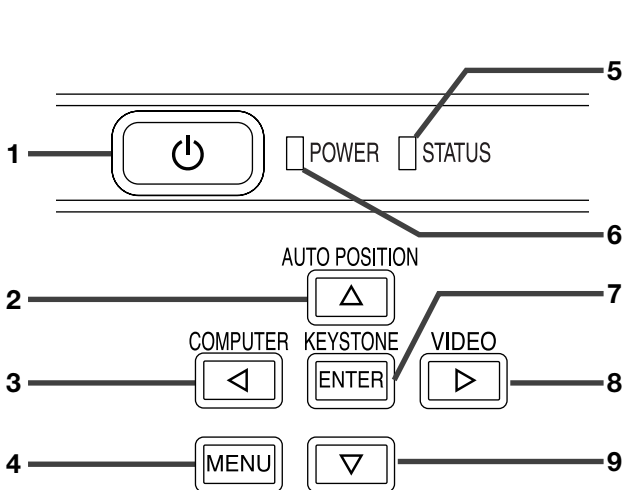

- 1 POWER button
- 2 AUTO POSITION/▲ button
- 3 COMPUTER/◀ button
- 4 MENU button
- 5 STATUS indicator
- 6 POWER indicator
- 7 KEYSTONE/ENTER button
- 8 VIDEO/▶ button
- 9 ▼ button

Important:

- While the menu or the screen for the keystone adjustment or password entry is being displayed, the COMPUTER, VIDEO, and AUTO POSITION buttons function as the ◀, ▶, and ▲ buttons respectively.
- While the menu is on the screen, the KEYSTONE button functions as the ENTER button.

Terminal panel

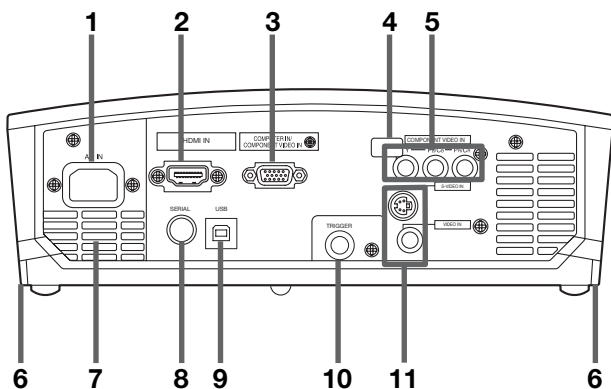

- 1 Power jack
- 2 HDMI IN terminal (HDMI 19-pin)
- 3 COMPUTER IN/COMPONENT VIDEO IN terminal (Mini D-SUB 15-pin)
- 4 Remote control sensor (Rear)
- 5 COMPONENT VIDEO IN terminals
- 6 Foot adjustment buttons (Left/Right)
- 7 Air outlet grille
- 8 SERIAL terminal (8-pin)
 - Used for projector control by computer. Contact your dealer for details.
- 9 USB terminal
 - Used for adjustment by service person.
- 10 TRIGGER terminal
 - Used for the optional electric screen.
- 11 VIDEO IN and S-VIDEO IN terminals

Preparing your projector (continued)

Bottom side

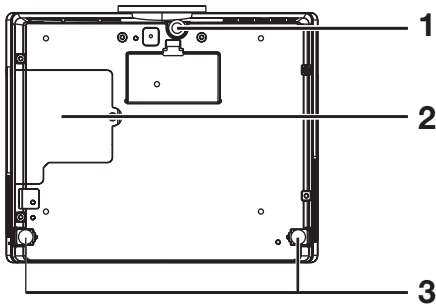

- 1 Adjustment foot (Front)
- 2 Lamp cover
- 3 Adjustment feet (Rear)

Caution:

Do not replace the lamp immediately after using the projector because the lamp would be extremely hot and it may cause burns.

Remote control

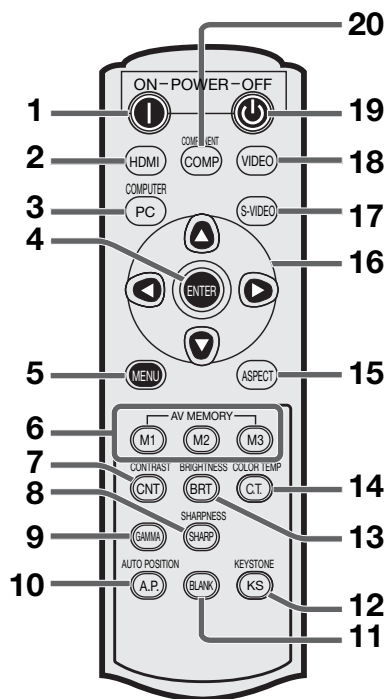

- 1 ON (I) button
- 2 HDMI button
- 3 COMPUTER button
- 4 ENTER button
- 5 MENU button
- 6 AV MEMORY buttons
- 7 CONTRAST button*
- 8 SHARPNESS button*
- 9 GAMMA button*
- 10 AUTO POSITION button
- 11 BLANK button
- 12 KEYSTONE button
- 13 BRIGHTNESS button*
- 14 COLOR TEMP button*
- 15 ASPECT button
- 16 Direction buttons
- 17 S-VIDEO button
- 18 VIDEO button
- 19 OFF () button
- 20 COMPONENT button

* : See below for the picture quality adjusting buttons.

Important:

- When you press any button on the remote control, the buttons on the remote control are lit. Wait approx. 5 seconds after releasing the button to turn them off.
- The direction buttons are used for the keystone adjustment and fine adjustment (◀ and ▶ buttons only).

Using the picture quality adjusting buttons

When you press any of the picture quality adjusting buttons, the screen for adjusting the picture quality appears. Adjust the picture quality by pressing the ◀ and ▶ buttons. The picture quality adjustment can be made alternatively in the IMAGE menu. (See page 24.) Items in the menus are shown in parentheses below.

CONTRAST (CONTRAST) Adjusts the contrast of the projected image.

BRIGHTNESS (BRIGHTNESS) Adjusts the brightness of the projected image.

COLOR TEMP (COLOR TEMP.) Selects one of the preset color temperatures. Color adjustment of USER mode is also available. (Refer to page 28.)

GAMMA (GAMMA MODE) Selects one of the preset gamma mode. Adjustment of USER mode is also available. (Refer to page 28.)

SHARPNESS (SHARPNESS) Adjusts the sharpness of the projected image.

Using the remote control

Operational range of the remote control

Front of projector

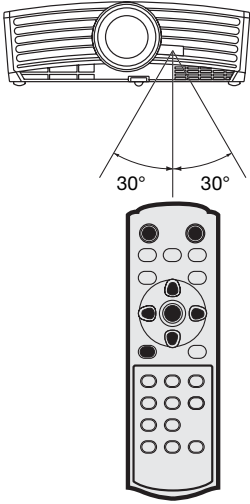

Rear of projector

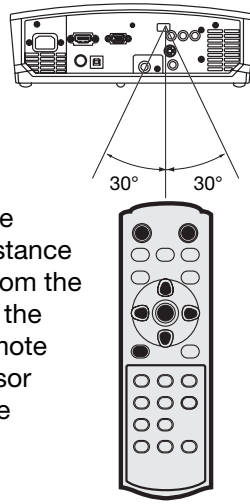

Operate the remote control within a distance of 10 m (30 feet) from the projector, pointing the IR beam at the remote control photo-sensor (front or rear) of the projector.

- Keep the remote control photo-sensor out of direct sunlight or fluorescent lamp light.
- Keep the remote control photo-sensor at least 2 m (6 feet) away from fluorescent lamps. Otherwise, the remote control may malfunction.
- If there is an inverter-operated fluorescent lamp near the remote control, the remote control operation may become unstable.
- When you use the remote control too close to the remote control sensor, the remote control may not work correctly.

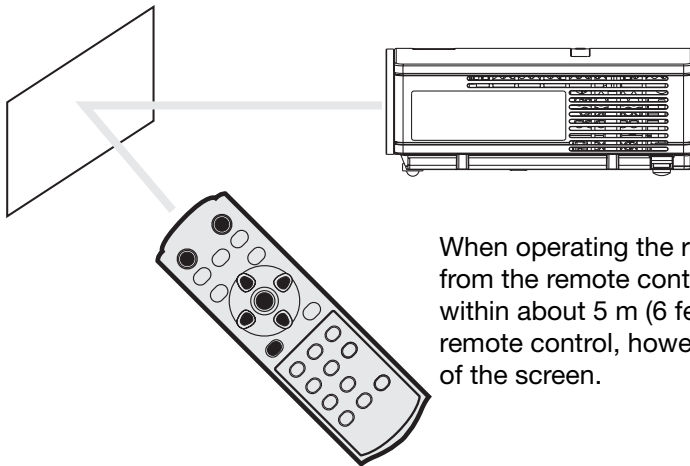

When operating the remote control, keep the distance from the remote control to the projector via the screen within about 5 m (6 feet). The operable range of the remote control, however, depends on the characteristics of the screen.

Reception angle

Vertical directions

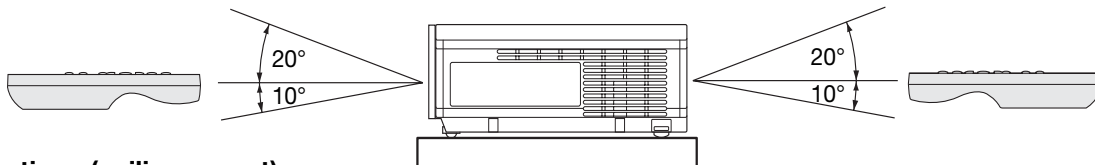

Vertical directions (ceiling mount)

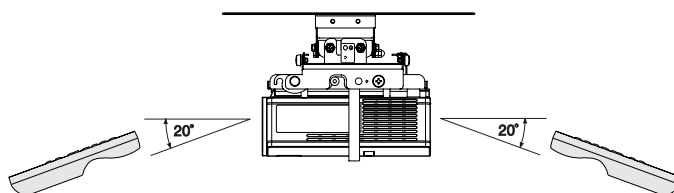

Setting up your projector

Setting up the screen

Install the screen perpendicularly to the projector. If the screen can not be installed in such a way, adjust the projection angle of the projector. (See below.)

- Install the screen and projector so that the projector's lens is placed at the same height and horizontal position of the screen center.
- Do not install the screen where it is exposed to direct sunlight or lighting. Light directly reflecting on the screen makes the projected images washed-out and hard to view.

SCREEN SIZE

You can keep the image display area within the screen by setting SCREEN SIZE in the IMAGE menu according to the size of the actual screen.

When setting SCREEN SIZE to CINEMA SCOPE(2.35:1):

- CinemaScope size movies are projected in the full screen.
- Set ASPECT in the FEATURE menu to 16:9 when displaying Vista-size images. In this case, they are squeezed horizontally.
- When ASPECT in the FEATURE menu is set to AUTO and 480p, 720p, or 1080i signal is input, the part for displaying subtitles is not projected.

Basic setup

Determine the distance from the screen to the projector according to the size of the images to be projected. (See page 12.)

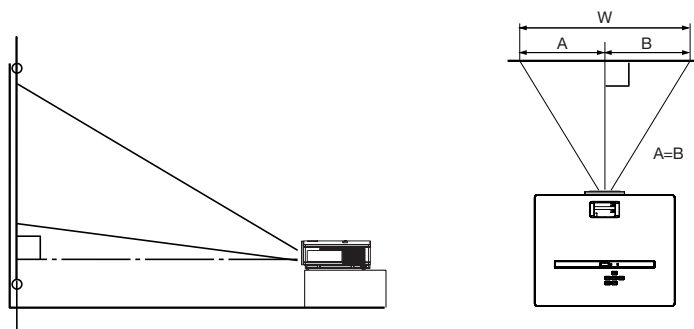

- Do not place this projector on a carpet or blanket because the exhaust vent and the intake vent on the bottom surface are blocked and the projector would heat, causing a breakdown or fire.
- Depending on the installation conditions, warm air that is emitted from the exhaust vents may flow into the intake vent, causing the projector to display "TEMPERATURE!!" and then stop projecting images.

Adjusting the projection angle

This projector is provided with three feet for adjusting the projection angle on the bottom surface. Adjust the projection angle depending on the position of the projector.

Adjustment of the projection angle

For the best projection, project images on a flat screen installed at 90 degrees to the floor. If necessary, tilt the projector using the two adjustment feet on the bottom of the projector.

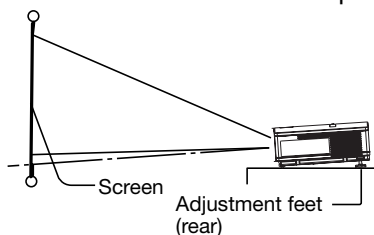

1. Tilt up the projector to the appropriate angle.
2. Press the foot adjustment buttons next to the adjustment feet (rear), and the adjustment feet will come out.
3. Release the buttons to lock the adjustment feet (rear) to that position.
4. Rotate the adjustment feet (rear) for fine adjustment.

After using the projector:

5. Put the adjustment feet (rear) back into the projector by pressing the foot adjustment buttons.
- If necessary, rotate the adjustment feet (front) for fine adjustment.

When projected images are distorted to a trapezoid:

When the screen and the projector are not placed perpendicularly to each other, projected images become trapezoidal. If you cannot make the projector and the screen perpendicular to each other by mechanical adjustments, adjust keystone. (See page 18.)

- When the keystone adjustment is applied, the correct aspect ratio may not be obtained.
- When the keystone adjustment is applied, the resolution lowers. In addition, vertical stripes appear and straight lines bend in images with complicated patterns. To prevent such symptoms, keep the screen and the projector perpendicular to each other as much as possible.
- Though the projected image may be distorted momentarily when you change the setting value of the keystone adjustment, such symptom is not a malfunction.
- Though the projected image may be distorted depending on the setting value of the keystone adjustment and the type of the input signal, such symptom is not a malfunction. In such a case, adjust the setting value within the range where the projected image is not distorted.
- The setting value displayed at the time of the keystone adjustment may vary depending on the type of the input signal.
- The keystone mode does not function when the REAL mode is applied.
- Displayed image may be distorted during keystone adjustment.

Front projection, ceiling mounting

For ceiling mounting, you need the ceiling mount kit designed for this projector. Ask a specialist for installation. For details, consult your dealer.

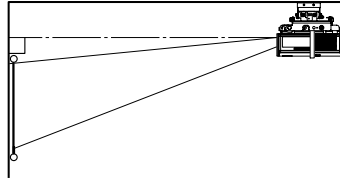

- The warranty on this projector does not cover any damage caused by use of any non-recommended ceiling mount kit or installation of the ceiling mount kit in an improper location.
- When using the projector mounted on the ceiling, set IMAGE REVERSE in the INSTALLATION menu to MIRROR INVERT. See page 25.
- When the projector is mounted on the ceiling, images may appear darker than those projected in the case of tabletop mounting. This isn't a product malfunction.
- Ask your installation specialist to provide an A/C power switch. When you do not use the projector, be sure to shut down the main power by the switch.
- Do not install the projector where the exhaust vents are exposed to air emitted by an air conditioning. Such installation may cause a breakdown.
- Do not install the projector near a fire alarm because it emits hot air from its exhaust vents.

Rear projection

Ask a specialist for installation. For details, consult your dealer.

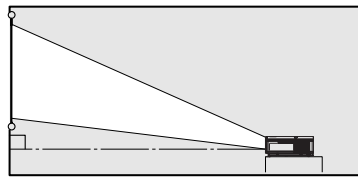

- For rear projection, set IMAGE REVERSE in the INSTALLATION menu to MIRROR. See page 25.

Caution:

- Placing the projector directly on a carpet impairs ventilation by the fans, causing damage or failure. Put a hard board under the projector to facilitate ventilation.
- Place the projector at least 50 cm (or 20 inch) away from the wall to prevent the air inlet grille and the air outlet grilles that emit hot air from being blocked.
- Do not use the projector in the following locations and manners, which may cause fire or electric shock.
 - In a dusty or humid place.
 - In a sideways or upside-down position.
 - Near a heater.
 - In an oily, smoky, or damp place such as a kitchen.
 - In direct sunlight.
 - Where the temperature rises high, such as in a closed car.
 - Where the temperature is lower than +41°F (or +5°C) or higher than +95°F (or +35°C).

TRIGGER terminal

The TRIGGER terminal on the rear of the projector is a terminal that outputs a 12 V signal to control an externally connected device (electric screen) when images are projected.

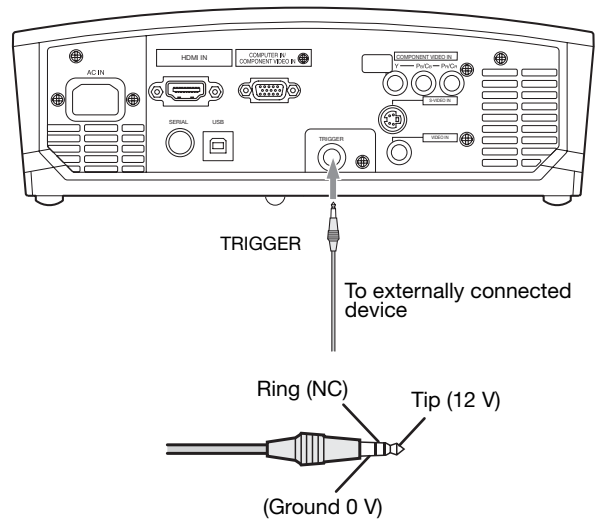

To use the TRIGGER terminal, set TRIGGER OUT to ON in the INSTALLATION menu. (The factory default is OFF.) Use the following steps to change the setting.

With the INSTALLATION menu:

(See page 24 for menu setting.)

1. Display the INSTALLATION menu.
2. Select TRIGGER OUT by pressing the ▲ or ▼ button.
3. Select ON by pressing the ◀ or ▶ button.

To cancel the menu:

4. Press the MENU button.

Caution:

- Do not use the signal output from the TRIGGER terminal as a power for other devices.
- Do not link the TRIGGER terminal with an audio terminal of other device because that device may be damaged.
- The rated current for the TRIGGER terminal is 200 mA. If you use a current exceeding this rating, a failure may occur.
- For information about electric screens, please contact screen manufacturers.

Setting up your projector (continued)

Screen size and projection distance

Refer to the following table to determine the screen size.

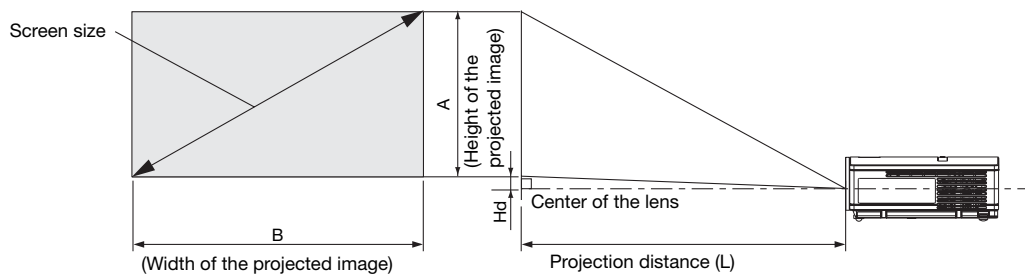

When the aspect ratio of the screen is 16:9

Screen size						Projection distance (L)					
Diagonal size		Height A		Width B		Min.		Max.		Hd	
inch	cm	inch	cm	inch	cm	inch	m	inch	m	inch	cm
40	102	19.6	50	34.9	89	56	1.4	68	1.7	6.6	17
60	152	29.4	75	52.3	133	85	2.2	103	2.6	9.9	25
80	203	39.2	100	69.7	177	114	2.9	139	3.5	13.2	33
100	254	49.0	125	87.2	221	143	3.6	174	4.4	16.5	42
150	381	73.5	187	130.7	332	216	5.5	262	6.6	24.7	63
200	508	98.1	249	174.3	443	289	7.3	349	8.9	32.9	84
250	635	122.6	311	217.9	553	362	9.2	-	-	41.2	105
275	699	134.8	342	239.7	609	398	10.1	-	-	45.3	115

- The above figures are approximate and may be slightly different from the actual measurements.
- Projection distance changes according to the setting of SCREEN SIZE in the IMAGE menu. The table above is in the case of "16:9."

When the aspect ratio of the screen is 4:3

When the aspect ratio of the screen is 4:3, the positional relation between the projected image and the screen is as shown on the right. Refer to the following table for installation.

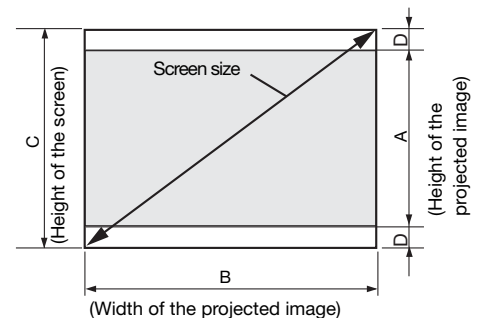

When the aspect ratio of the image is 16:9

Screen size						Size of the projected image				Black space (D)		Projection distance (L)					
Diagonal size		Height C		Width B		Height A		Width B		inch		cm		Hd			
inch	cm	inch	cm	inch	cm	inch	cm	inch	cm	inch	cm	inch	m	inch	cm		
40	102	24	61	32	81	18.0	46	32.0	81	3.0	8	51	1.3	63	1.6	6.0	15
60	152	36	91	48	122	27.0	69	48.0	122	4.5	11	78	2.0	95	2.4	9.1	23
80	203	48	122	64	163	36.0	91	64.0	163	6.0	15	105	2.7	127	3.2	12.1	31
100	254	60	152	80	203	45.0	114	80.0	203	7.5	19	132	3.3	159	4.0	15.1	38
150	381	90	229	120	305	67.4	171	120.0	305	11.3	29	198	5.0	240	6.1	22.7	58
200	508	120	305	160	406	89.9	228	160.0	406	15.0	38	265	6.7	320	8.1	30.2	77
250	635	150	381	200	508	112.4	286	200.0	508	18.8	48	332	8.4	401	10.2	37.8	96
300	762	180	457	240	610	134.9	343	240.0	610	22.6	57	398	10.1	-	-	45.3	115

- The above figures are approximate and may be slightly different from the actual measurements.
- Projection distance changes according to the setting of SCREEN SIZE in the IMAGE menu. The table above is in the case of "16:9."

Viewing video images

A. Connecting the projector to video equipment

- When the projector and the connected devices are located too close to each other, the projected image may be affected by their interference.
- See the owner's guide of each device for details about its connections.

Preparation:

- Make sure that the power of the projector and that of the video equipment are turned off.

Basic home theater system connection

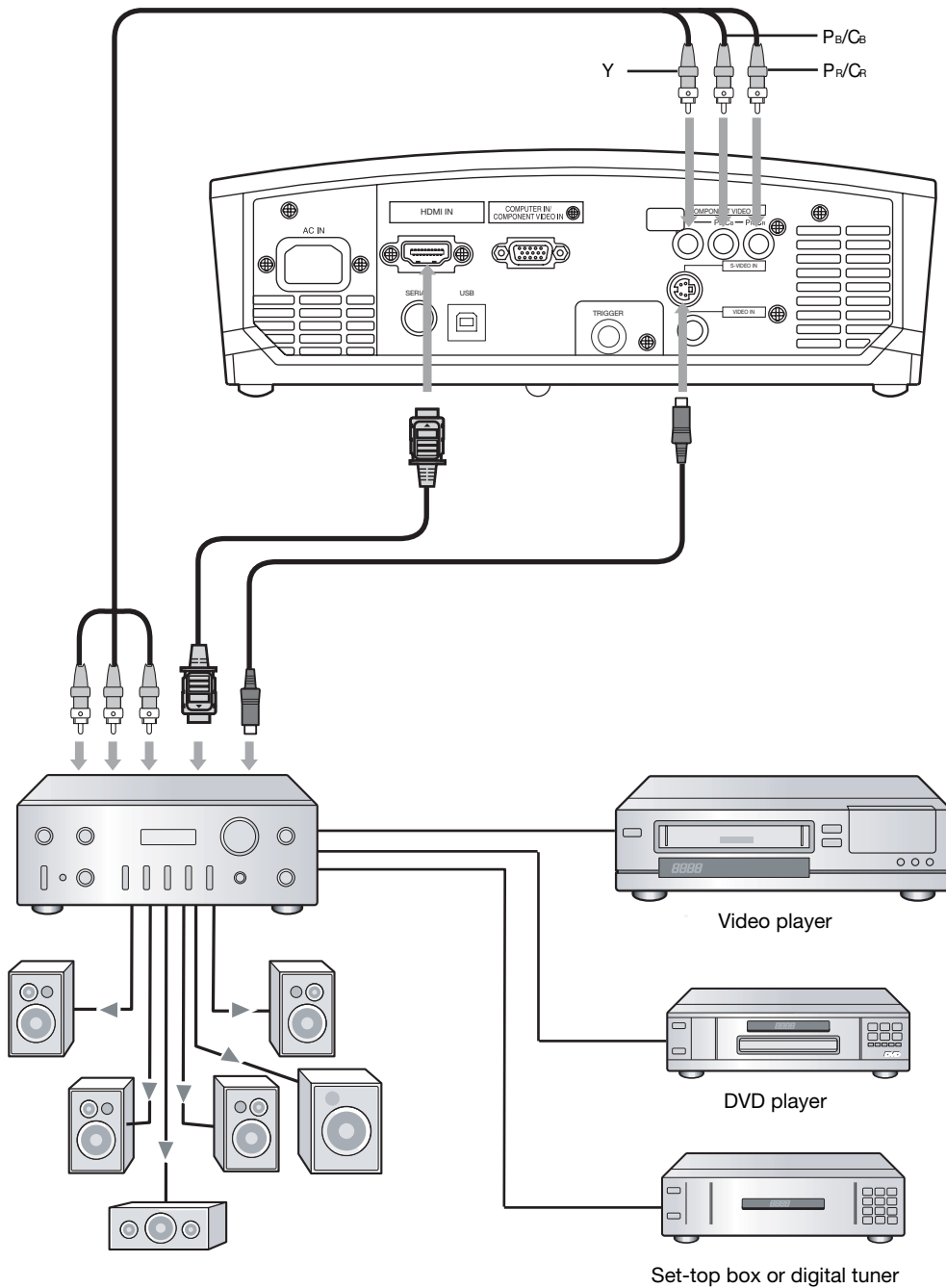

Viewing video images (continued)

Connecting to a video player, etc.

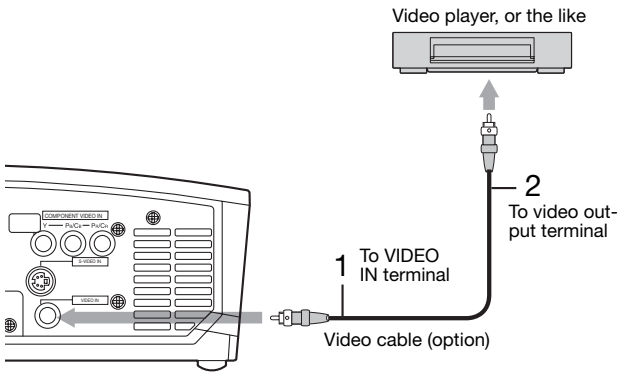

1. Connect one end of the optional video cable to the VIDEO IN terminal of the projector.
2. Connect the other end of the video cable to the video output terminal of the video equipment.

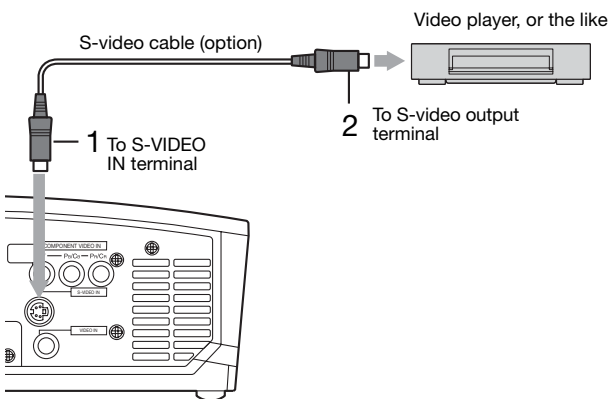

When the video equipment is equipped with the S-video output terminal, make the connection as follows:

1. Connect one end of the optional S-video cable to the S-VIDEO IN terminal of the projector.
2. Connect the other end of the S-video cable to the S-video output terminal of the video equipment.

- Also read the instruction manual of the equipment to be connected.
- Contact your dealer for details of connection.

When a TV tuner or VCR is connected:

When you use this projector with a TV tuner or VCR connected, no image may appear or a message of NO SIGNAL may appear on the screen when you change the channel via any channel that is not being received. In such a case, set the channels of the TV tuner or VCR again. To avoid such symptom, use the TV tuner or VCR with its channel skip function (that is a function not to display channels that are not being received) enabled.

Connecting to a DVD player or HDTV decoder

To connect this projector to video equipment that has component video output terminals, such as a DVD player, use the COMPONENT VIDEO IN terminals.

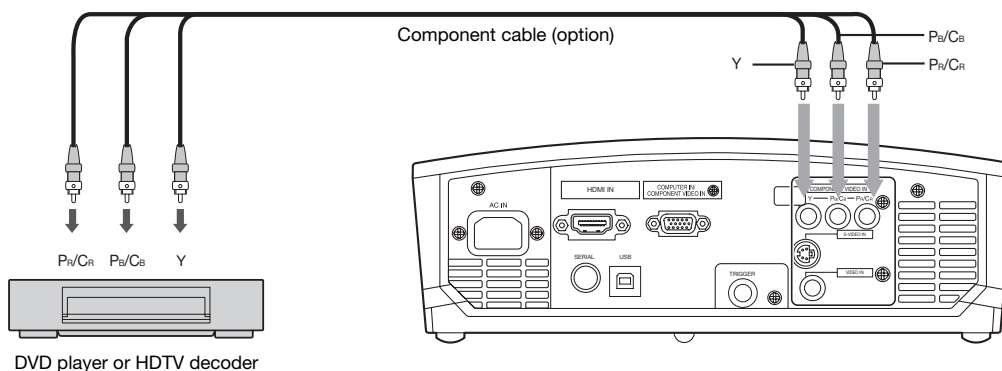

- The terminal's names Y, P_B, and P_R are given as examples of when a HDTV decoder is connected.
- The terminal's names vary depending on the connected devices.
- Images may not be projected correctly depending on the type of the DVD player you use.
- Though it may take some time before an image is displayed on the screen depending on the type of the input signal, such symptom is not a malfunction.
- When connecting a HDTV decoder having RGB output terminals, set COMPUTER INPUT to RGB in the SIGNAL menu.

Connecting to video equipment having a HDMI terminal or DVI-D terminal

You can project high-quality images by connecting the HDMI IN terminal of this projector to video equipment having a HDMI output terminal or a DVI-D output terminal. In addition, this projector supports HDCP and is able to receive encrypted digital video data that are output from DVD players.

- Select HDMI as the input source.
- HDCP (High-bandwidth Digital Content Protection), developed by Intel Corporation, is a method to encrypt digital video data for the purpose of copy protection.
- HDMI (High-Definition Multimedia Interface) is fully backward compatible with computers, displays and consumer electronics devices incorporating the DVI standards.
- This projector can be linked with video devices equipped with HDMI output terminal or DVI-D output terminal. However, with some of them, this projector may not display any image or not operate correctly.
- If this projector doesn't display any image or not operate correctly, see the operation manual of the video device for its connection.
- When you use the video equipment other than HDMI conformity product, the image may not be projected properly.
- Use of a long cable may decrease the quality of projected images.

Connection (for video equipment having an HDMI terminal)

- Use a commercially available HDMI (with HDMI logo) cable.

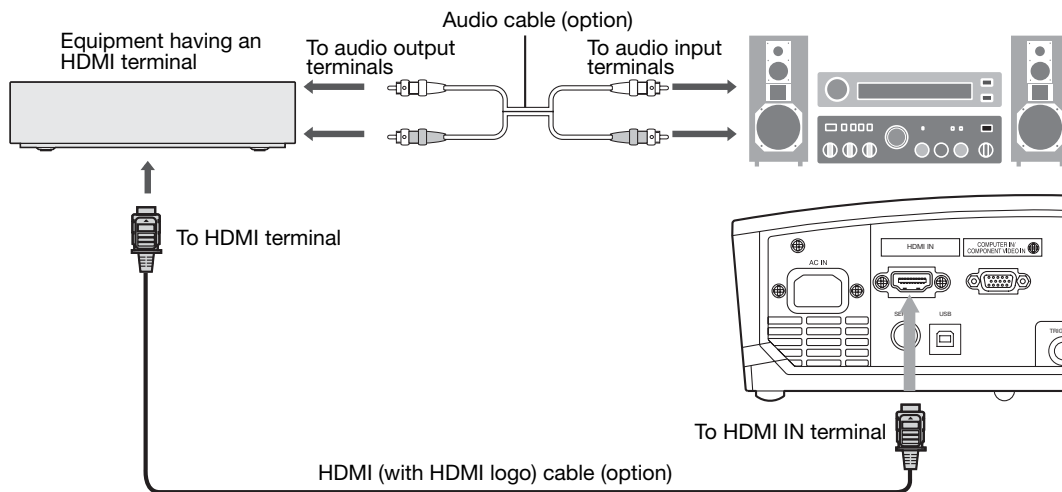

Connection (for video equipment having a DVI-D terminal)

- Use a commercially available DVI-HDMI conversion cable.

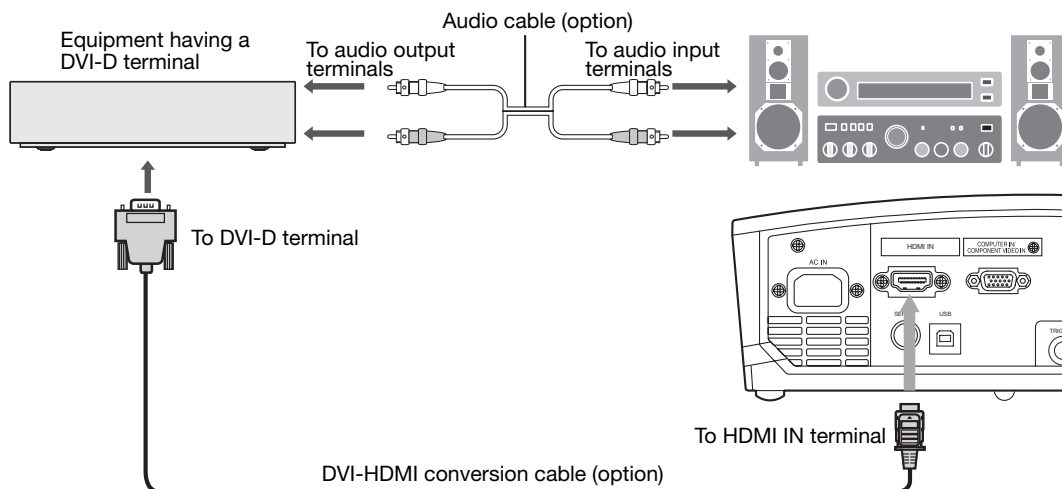

- Images may not be projected correctly depending on the type of the video equipment you use.

Viewing video images (continued)

When you connect this projector and a DVI-Digital device (such as a DVD player) via the HDMI terminal or DVI-D (HDCP) terminal, black color may appear dark and deep, depending on the type of the connected device.

- This depends on the black level setting of the connected device. There are two kinds of methods to digitally transfer image data, in which different black level settings are employed respectively. Therefore, the specifications of the signals output from DVD players differ, depending on the type of the digital data transfer method they use.
- Some DVD players are provided with a function to switch the methods to output digital signals. When your DVD player is provided with such function, set it as follows.

EXPAND or ENHANCED → NORMAL

- See the users guide of your DVD player for details.
- When your digital device does not have such function, adjust the BRIGHTNESS to +16 and CONTRAST to -17 in the IMAGE menu of this projector, or adjust the black color by viewing the image.

B. Plugging in the power cord

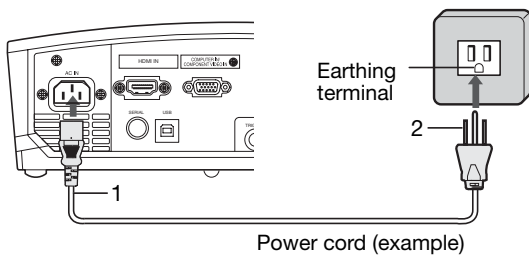

1. Plug the attached power cord into the power cord inlet of this projector.
2. Plug the other end of the power cord into a power outlet.

- The power cords for use in the U.S. and Europe are included with this projector. Use the appropriate one for your country.
- This projector uses the power plug of three-pin grounding type. Do not take away the grounding pin from the power plug. If the power plug doesn't fit your wall outlet, ask an electrician to change the wall outlet.
- The provided power cord for the U.S. is rated at 120 V. Never connect this cord to any outlet or power supply using other voltages or frequencies than rated. If you use a power supply using other voltage than rated, prepare an appropriate power cord separately.
- Use 100-240 V AC 50/60 Hz to prevent fire or electric shock.
- Do not place any objects on the power cord or do not place the projector near heat sources to prevent damage to the power cord. If the power cord should be damaged, contact your dealer for replacement because it may cause fire or electric shock.
- Do not modify or alter the power cord. If the power cord is modified or altered, it may cause fire or electric shock.

Caution:

- Plug in the power cord firmly. When unplugging, hold and pull the power plug, not the power cord.
- Do not plug in or out the power cord with your hand wet. It may cause electric shock.

C. Projecting images

Preparation:

- Remove the lens cap.
- Turn on the power of the connected video equipment.

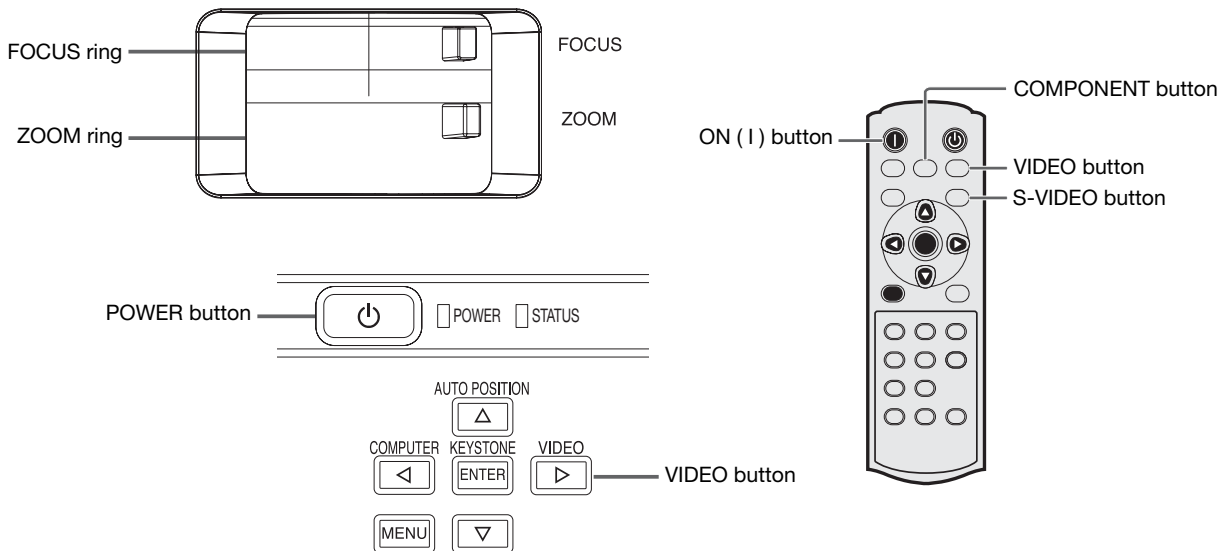

1. Confirm the POWER indicator lights-up red.
 - If the projector was turned off before the lamp had cooled down sufficiently, the fan may start rotating and the POWER button may not work after the power cord is plugged. (The STATUS indicator blinks green.) After the fan stops rotating, press the POWER button to turn back on the POWER indicator.
2. Press the POWER button on the projector or ON (I) button on the remote control.
 - It may take about one minute for the lamp to light up.
 - The lamp fails to light up on rare occasions. In such a case, wait for a few minutes and then try again.
 - Do not cover the lens with the lens cap while the lamp is on. Do not strip off the aluminium sheet inside the lens cap.
 - After the POWER button is pressed, the image may flicker before the lamp becomes stable. This is not a product malfunction.
 - The STANDARD lamp mode is activated by default whenever the projector is turned on. When the LOW LAMP MODE has been chosen, the default STANDARD lamp mode is switched to the LOW lamp mode in 1 minute.
 - The projector starts warming up when the POWER button is pressed. During the warm-up process, images may appear dark and no commands are accepted.
 - By blinking red, the STATUS indicator indicates that the lamp should be replaced soon. Replace the lamp when the STATUS indicator blinks red. (See pages 33 and 36.)
3. Select an input source.
 - Press the VIDEO button on the projector or the VIDEO, S-VIDEO or COMPONENT button on the remote control that is corresponding to the terminal in use.
 - The input source is switched between VIDEO, S-VIDEO and COMPONENT every time you press the VIDEO button on the projector.
 - The projector automatically selects the appropriate signal format. The selected signal format is displayed on the screen.
 - The VIDEO, S-VIDEO and COMPONENT buttons don't function while the menu is being displayed.
 - Though it may take some time before an image is displayed on the screen depending on the type of the input signal, such symptom is not a malfunction.
 - Some images become easier to view when the setting of aspect ratio is changed. (See page 19.)
4. Adjust the position of the projector to keep an appropriate projection distance with which images are projected in their specified sizes.
5. Adjust the position of the projector so that the projector and the screen are perpendicular to each other. (See page 10.)
 - When the projector cannot be positioned perpendicularly to the screen, adjust the projection angle. (See page 10.)
6. Adjust the size of the projected image by turning the ZOOM ring.
7. Adjust the focus by turning the FOCUS ring.

Repeat steps 4 to 7, if necessary.

Viewing video images (continued)

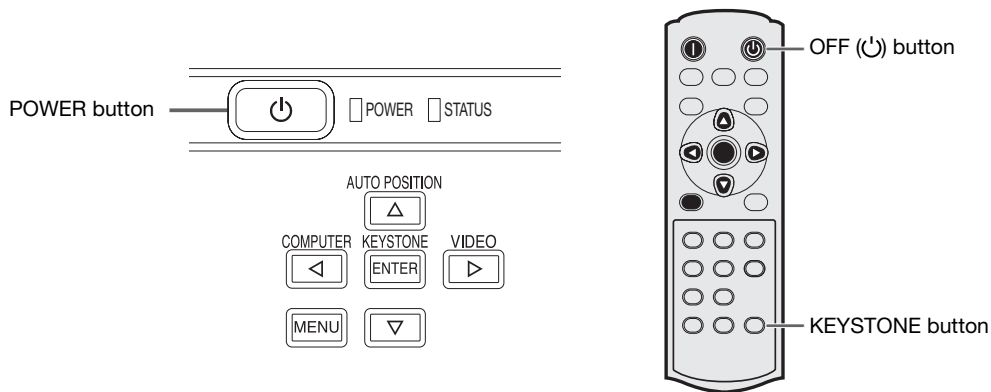

To stop projecting:

8. Press the POWER button on the projector or the OFF (⏻) button on the remote control.
 - A confirmation message is displayed.
 - To cancel the procedure, leave the projector for a while or press the MENU button.
9. Press the POWER button on the projector or the OFF (⏻) button on the remote control again.
 - The lamp goes out and the projector goes into a standby mode. In this standby mode, the STATUS indicator blinks green.
10. Wait about one minute.
 - During this period of one minute in the standby mode, the intake fan and exhaust fan rotate to cool the lamp.
 - The lamp can't be lit again for one minute after turning off the projector for safety purpose. It will take another one minute for the STATUS indicator to go out. If you want to turn on the projector again, wait until the indicator goes out, and then press the POWER button.
 - The air outlet fans rotate faster as the temperature around the projector rises.
 - Do not unplug the power cord while the STATUS indicator is blinking. Unplugging the power cord immediately after use may cause a lamp breakdown.
 - Though the fan makes loud sound during cooling, such symptom is not a malfunction.
11. Unplug the power cord from the outlet.
 - The POWER indicator will go out.
 - If the power cord should be unplugged accidentally while either the air inlet fan or the air outlet fans are operating or the lamp is on, allow the projector to cool down for 10 minutes with the power off. To light the lamp again, press the POWER button. If the lamp doesn't light up immediately, repeat pressing the POWER button two or three times. If it should still fail to light up, replace the lamp.
 - Cover the lens with the lens cap to protect it from dust.

When projected images are distorted to a trapezoid:

To correct vertical and horizontal keystone distortion, press the KEystone button on the projector or the remote control to display KEystone, and adjust the image by pressing the ►, ◀, ▲, or ▼ button.

In the following cases:



Press the ► button. Press the ◀ button. Press the ▼ button. Press the ▲ button.













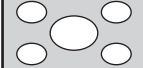

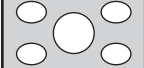
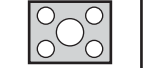





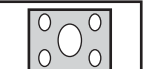







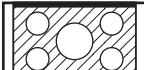

Important:

- You can correct the vertical and horizontal keystones at the same time. However, their adjustment ranges are limited in such correction.
- When the keystone adjustment is carried out, the adjustment value is indicated. Note that this value doesn't mean a projection angle.
- The allowable range of the adjustment value in the keystone adjustment varies depending on the installation conditions.
- When the keystone adjustment takes effect, the resolution decreases. In addition, stripes may appear or straight lines may bend in images with complicated patterns. They are not due to product malfunctions.
- Noise may appear on the screen during the keystone adjustment because of the type of the video signal being projected and the setting values of the keystone adjustment. In such cases, set the keystone adjustment values in the range where the image is displayed without noise.
- When the keystone adjustment is carried out, the image may not be displayed correctly because of the type of input signal.

Setting the aspect ratio

You can change the aspect ratio of the input video signal (or the ratio of width to height of the image). Change the setting according to the type of the input video signal.

 : Signal size  : Image area

Original image size		4:3	16:9	ZOOM1	ZOOM2	STRETCH	REAL
		Aspect ratio changes depending on the input signal.	Squeezed image is expanded to 16:9.	CinemaScope image is enlarged and displayed together with subtitles.	Vista image is enlarged and displayed together with subtitles.	Image is enlarged to 16:9 while the center aspect ratio remains unchanged.	Input signal is displayed in its original size.
4:3 image (480i, 576i, 480p, 576p, and PC)							
Squeezed 4:3 (480i, 576i, 480p, 576p)							
4:3 CinemaScope (480i, 576i, 480p, 576p)							
4:3 Vista image (480i, 576i, 480p, 576p)							
16:9 image (720p, 1080i)							

- Bold frames are recommended modes.
- When ASPECT is set to AUTO, an optimum aspect ratio is automatically selected depending on the input signal.
- When ASPECT is set to ZOOM1 or ZOOM2, display position can be changed with ▲ or ▼ button on the remote control.
- When ZOOM1 or ZOOM2 is selected while 480i signal is input, the display area becomes smaller than that of other signals (such as 576i, 480p, and 576p).
- OVER SCAN and SHUTTER in the SIGNAL menu are not available in the STRETCH mode.
- Display pattern changes according to the setting of SCREEN SIZE in the IMAGE menu. The table above is in the case of "16:9."
- This projector is equipped with a function to change the aspect ratio. If you select an aspect ratio that is inconsistent with that of the input signal, images around the screen edges may be hidden or deformed. When viewing original video works reflecting the authors' intentions, you are recommended to keep their aspect ratios unchanged.
- It may be an infringement of the rights protected by the copyright law to project images compressed or enlarged by changing the aspect ratio in public areas, such as inside and outside shops and hotels, for commercial or public viewing purposes.

How to change the settings:

With the remote control:

1. Press the ASPECT button.
 - Every time the ASPECT button is pressed, the aspect mode changes from AUTO to 4:3, to 16:9, to ZOOM1, to ZOOM2, to STRETCH, to REAL, and back to AUTO.
 - When the keystone adjustment is applied, the REAL mode can not be selected.
 - Some modes are not available with certain signals.

With the FEATURE menu:

(See page 24 for menu setting.)

1. Display the FEATURE menu.
2. Select ASPECT by pressing the ▲ or ▼ button.
3. Select your desired aspect ratio by pressing the ◀ or ▶ button.



To cancel the menu:

4. Press the MENU button.

Important:

- When a 4:3 image is kept displayed for a long time before displaying 16:9 image, the afterimages of the black bars may appear on the 16:9 image screen. Consult your dealer in this case.

Viewing computer images

A. Connecting the projector to a computer

Preparation:

- Make sure that the power of the projector and that of the computer are turned off.
- When connecting the projector to a desktop computer, disconnect the RGB cables that are connected to the monitor.

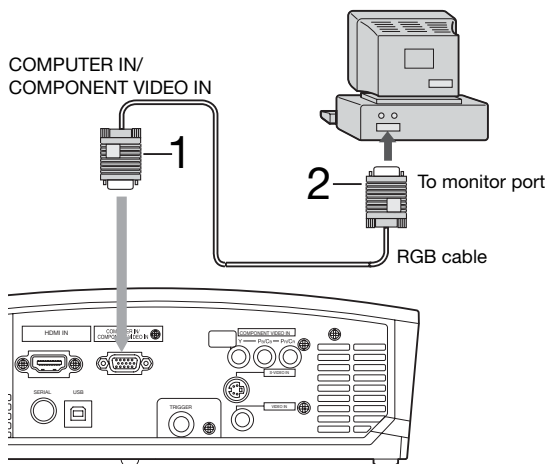

For analog connection:

1. Connect one end of the supplied RGB cable to the COMPUTER IN/COMPONENT VIDEO IN terminal of the projector.
2. Connect the other end of the RGB cable to the monitor port of the computer.
 - Additional devices, such as a conversion connector and an analog RGB output adapter, are required depending on the type of the computer to be connected.
 - When viewing images supplied from an analog-connected computer, press the COMPUTER button on the remote control.

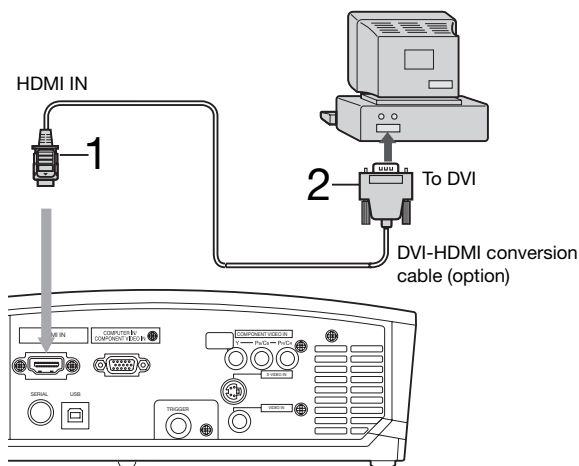

For digital connection:

1. Connect one end of a commercially available DVI-HDMI conversion cable to the HDMI IN terminal of the projector.
2. Connect the other end of the DVI-HDMI conversion cable to the DVI terminal of the computer.
 - Additional devices, such as a conversion connector and an analog RGB output adapter, are required depending on the type of the computer to be connected.
 - When viewing images supplied from a digital-connected computer, press the HDMI button on the remote control.
 - The signal input to the HDMI IN terminal is not output from the COMPUTER OUT terminal.
 - Make sure to connect computer with HDMI cable before starting the computer. If connecting the computer with HDMI cable after starting the computer, the image signal may not be output from HDMI terminal of computer.

- Turn on the power of the projector before that of the computer.
- Additional devices, such as a conversion connector and an analog RGB output adapter, are required depending on the type of the computer to be connected.
- Use of a long cable may decrease the quality of projected images.
- Also read the instruction manual of the equipment to be connected.
- Images may not be projected correctly, depending on the type of the computer connected.
- Contact your dealer for details of connection.

About DDC

The COMPUTER IN/COMPONENT VIDEO IN terminal of this projector complies with the DDC1/2B standard and the HDMI IN terminal complies with the DDC2B standard. When a computer supporting this standard is connected to this terminal, the computer will automatically load the information from this projector and prepare for output of appropriate images.

- After connecting a computer supporting this standard to this terminal, plug the power cord of the projector in the wall outlet first, and then boot up the computer.

B. Plugging the power cord

Plug the power cord in the same way as described in “Viewing video images.” (See page 16.)

C. Projecting images

Preparation:

- Remove the lens cap.
- Turn on the power of the connected computer.

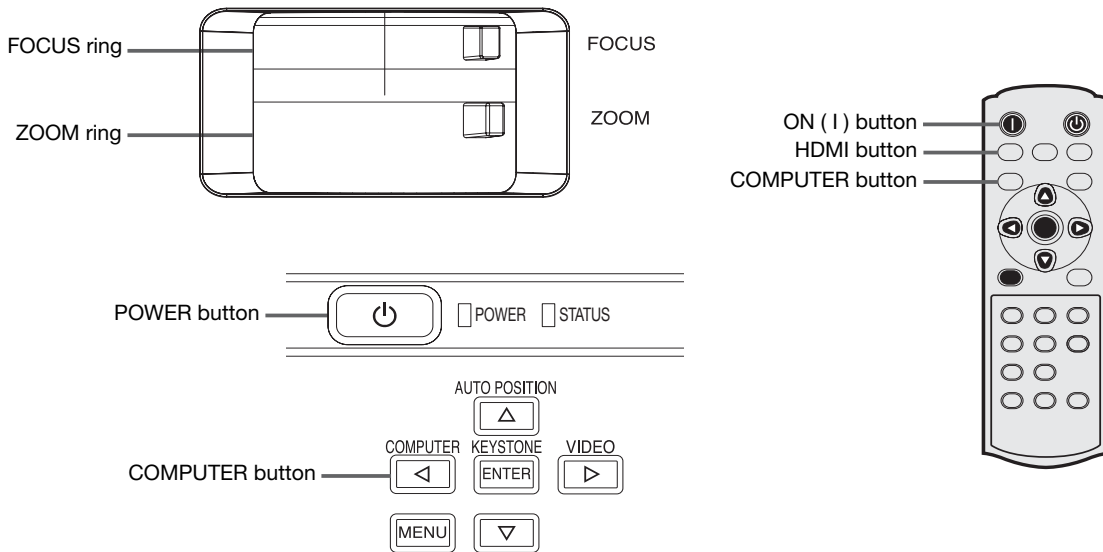

1. Confirm the POWER indicator lights-up red.
 - If the projector was turned off before the lamp had cooled down sufficiently, the fan may start rotating and the POWER button may not work after the power cord is plugged. (The STATUS indicator blinks green.) After the fan stops rotating, press the power button to turn back on the POWER indicator.
2. Press the POWER button on the projector or ON (I) button on the remote control.
 - It may take about one minute for the lamp to light up.
 - The lamp fails to light up on rare occasions. In such a case, wait for a few minutes and then try again.
 - Do not cover the lens with the lens cap while the lamp is on. Do not strip off the aluminium sheet inside the lens cap.
 - After the POWER button is pressed, the image may flicker before the lamp becomes stable. This is not a product malfunction.
 - The STANDARD lamp mode is activated by default whenever the projector is turned on. When the LOW LAMP MODE has been chosen, the default STANDARD lamp mode is switched to the LOW lamp mode in 1 minute.
 - The projector starts warming up when the POWER button is pressed. During the warm-up process, images may appear dark and no commands are accepted.
 - By blinking red, the STATUS indicator indicates that the lamp should be replaced soon. Replace the lamp when the STATUS indicator blinks red. (See pages 33 and 36.)
3. Select an input source.
 - Press the COMPUTER button on the projector or the COMPUTER or HDMI button on the remote control that is corresponding to the terminal in use.
 - The input source is switched between COMPUTER and HDMI every time you press the COMPUTER button on the projector.
 - Though it may take some time before an image is displayed on the screen depending on the type of the input signal, such symptom is not a malfunction.
 - Images may not be projected in the correct position, depending on the type of the input signal. In such a case, press the AUTO POSITION button. (See page 22.)
 - The projector automatically selects the appropriate signal format. The selected signal format is displayed on the screen.
 - The COMPUTER and HDMI buttons don't function while the menu is being displayed.
 - When COMPUTER is chosen as the source, images supplied from the computer may flicker. Press the ◀ or ▶ button on the remote control to reduce flicker, if it occurs.
4. Adjust the position of the projector to keep an appropriate projection distance with which images are projected in their specified sizes.
5. Adjust the position of the projector so that the projector and the screen are perpendicular to each other. (See page 10.)
 - When the projector cannot be positioned perpendicularly to the screen, adjust the projection angle. (See page 10.)
6. Adjust the size of the projected image by turning the ZOOM ring.
7. Adjust the focus by turning the FOCUS ring.

Repeat steps 4 to 7, if necessary.

Viewing computer images (continued)

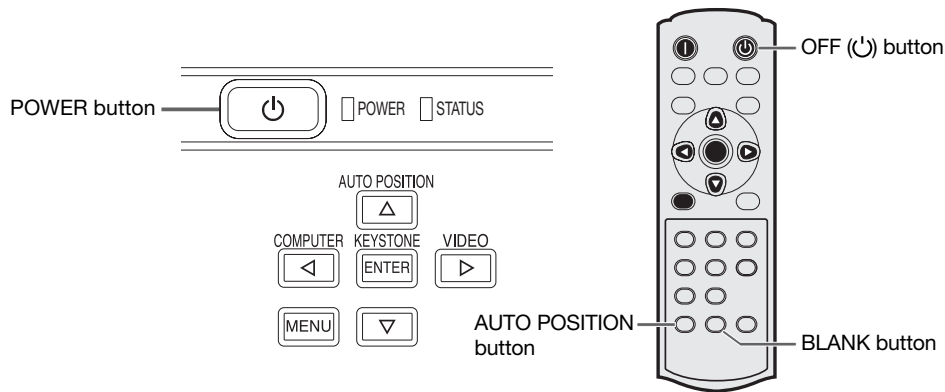

To stop projecting:

8. Press the POWER button on the projector or the OFF (⏻) button on the remote control.
 - A confirmation message is displayed.
 - To cancel the procedure, leave the projector for a while or press the MENU button.
9. Press the POWER button on the projector or the OFF (⏻) button on the remote control again.
 - The lamp goes out and the projector goes into a standby mode. In this standby mode, the STATUS indicator blinks green.
10. Wait about one minute.
 - During this period of one minute in the standby mode, the intake fan and exhaust fan rotate to cool the lamp.
 - The lamp can't be lit again for one minute after turning off the projector for safety purpose. It will take another one minute for the STATUS indicator to go out. If you want to turn on the projector again, wait until the indicator goes out, and then press the POWER button.
 - The air outlet fans rotate faster as the temperature around the projector rises.
 - Do not unplug the power cord while the STATUS indicator is blinking. Unplugging the power cord immediately after use may cause a lamp breakdown.
 - Though the fan makes loud sounds during cooling, such symptom is not a malfunction.
11. Unplug the power cord from the outlet.
 - The POWER indicator will go out.
 - If the power cord should be unplugged accidentally while either the air inlet fan or the air outlet fans are operating or the lamp is on, allow the projector to cool down for 10 minutes with the power off. To light the lamp again, press the POWER button. If the lamp doesn't light up immediately, repeat pressing the POWER button two or three times. If it should still fail to light up, replace the lamp.
 - Cover the lens with the lens cap to protect it from dust.

BLANK mode

The video signal is temporarily muted when the BLANK button is pressed. To cancel muting, press the BLANK button again.

- It takes several seconds to disable the BLANK mode.

AUTO POSITION button

When the image supplied from the computer is displaced, carry out the following procedure.

1. Display a bright image (such as a full-screen display of the Recycle Bin window).
 2. When the screen saver has been enabled, disable it.
 3. Press the AUTO POSITION button.

The projector automatically makes optimum positional settings for the input signal.
- If the image is not projected in the correct position even after you press the AUTO POSITION button several times, change the settings in the SIGNAL menu to put the image in the correct position. (See page 29.)
 - When you carry out this procedure with a dark image, the image may be displaced.

When connecting to a notebook computer:

When the projector is connected to a notebook computer, images may not be projected in some cases. In such cases, set the computer so that it can output signals externally. The setting procedure varies depending on the type of the computer. See the instruction manual of your computer.

Example of the setting procedure for external output

Press the [Fn] key and any of the keys [F1] to [F12] at the same time. (The key to be pressed depends on the type of the computer you use.)

Menu operation

- Menus are not displayed when no signal is supplied to the projector.

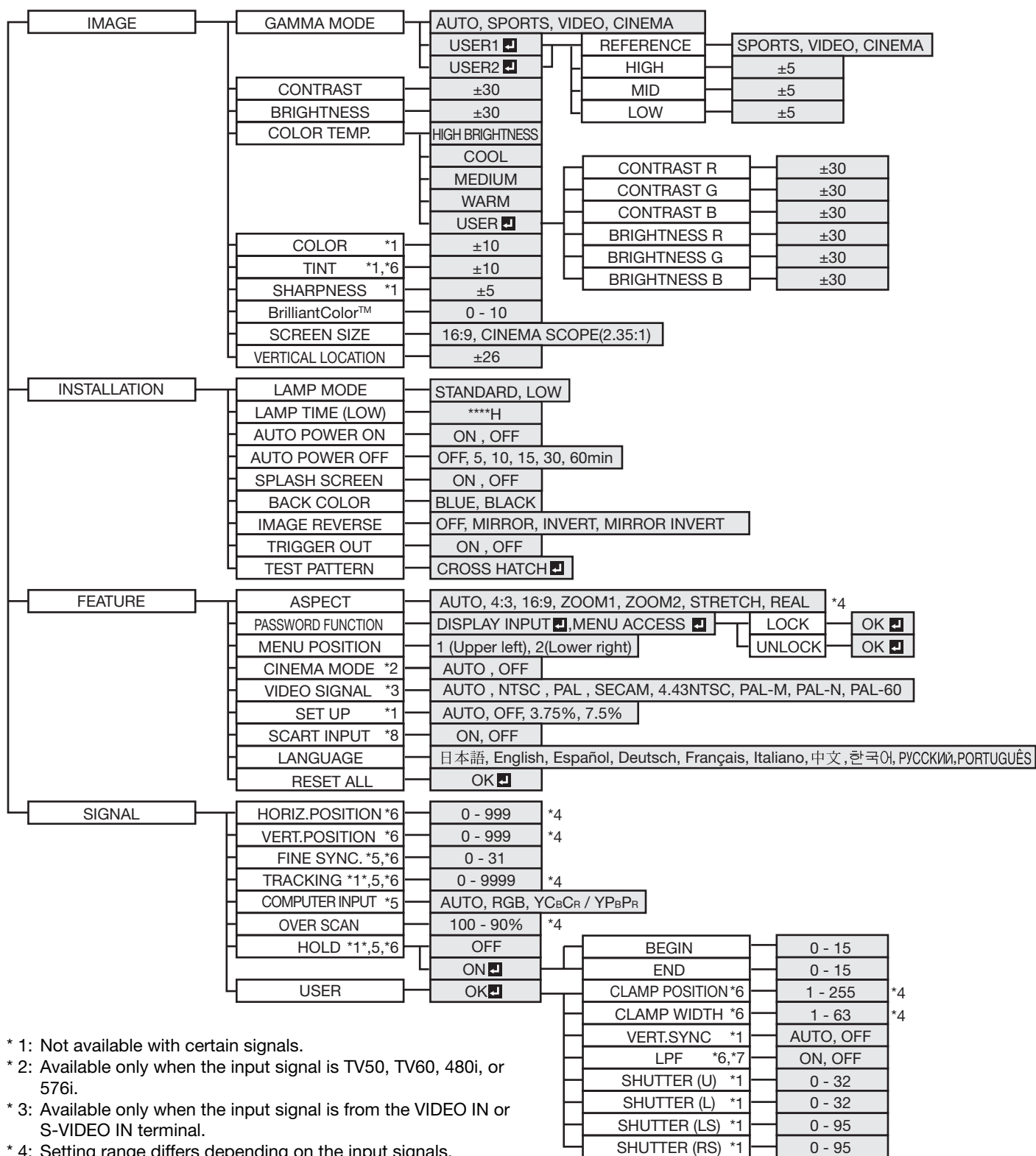

- * 1: Not available with certain signals.
- * 2: Available only when the input signal is TV50, TV60, 480i, or 576i.
- * 3: Available only when the input signal is from the VIDEO IN or S-VIDEO IN terminal.
- * 4: Setting range differs depending on the input signals.
- * 5: Not available when the input signal is from the VIDEO IN or S-VIDEO IN terminal.
- * 6: Not available when the input signal is from the HDMI IN terminal.
- * 7: Available only when the input signal is 480i, 480p, 576i, or 576p.
- * 8: Available only when the input signal is from the COMPUTER IN/COMPONENT VIDEO IN terminal.

Menu operation (continued)

How to set the menus:

The following describes how to set AUTO POWER OFF time as an example.

1. Press the MENU button.
 - When no signal is applied, the menu would not appear.



2. Press the ◀ or ▶ button to select a menu to use.



3. Press the ENTER button (or ▼ button).

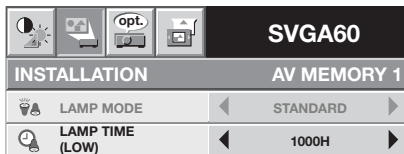

4. Press the ▲ or ▼ button to select an item to adjust.



5. Set the selected item by pressing the ◀ or ▶ button.



To cancel the menu:

6. Press the MENU button several times.

Important:

- When the MENU button doesn't function, unplug the power cord from the wall outlet. Wait about 10 minutes, plug the power cord in, and try again.
- After selecting the items marked with , press the ENTER button.

Available settings in the menus

Set the following items on their relevant menus.



1. IMAGE menu

IMAGE		AV MEMORY 1
GAMMA MODE	◀ AUTO ▶	
CONTRAST	◀ 0 ▶	
BRIGHTNESS	◀ 0 ▶	
COLOR TEMP.	◀ MEDIUM ▶	
COLOR	◀ 0 ▶	
TINT	◀ 0 ▶	
SHARPNESS	◀ 0 ▶	
BrilliantColor™	◀ 0 ▶	
SCREEN SIZE	◀ 16:9 ▶	
VERTICAL LOCATION	◀ 0 ▶	



2. INSTALLATION menu

INSTALLATION		AV MEMORY 1
LAMP MODE	◀ STANDARD ▶	
LAMP TIME (LOW)	◀ 1000H ▶	
AUTO POWER ON	◀ OFF ▶	
AUTO POWER OFF	◀ OFF ▶	
SPLASH SCREEN	◀ ON ▶	
BACK COLOR	◀ BLUE ▶	
IMAGE REVERSE	◀ OFF ▶	
TRIGGER OUT	◀ OFF ▶	
TEST PATTERN	CROSS HATCH 	

3. FEATURE menu

FEATURE		AV MEMORY 1
ASPECT	◀ AUTO ▶	
PASSWORD FUNCTION	◀ DISPLAY INPUT 	
MENU POSITION	◀ 1. 	
CINEMA MODE	◀ AUTO ▶	
VIDEO SIGNAL	◀ AUTO ▶	
SET UP	◀ AUTO ▶	
SCART INPUT	◀ OFF ▶	
LANGUAGE	◀ English ▶	
RESET ALL	◀ OK 	

1. IMAGE menu

ITEM	SETTING	FUNCTION
GAMMA MODE	AUTO	The proper gamma mode is automatically selected depending on the input signal. Default is AUTO.
	SPORTS	This is a bright mode suitable for watching sports images.
	VIDEO	This is a standard mode suitable for watching video images, etc.
	CINEMA	This is a mode for watching movies in dim lighting as in a theater.
	USER1  / USER2 	Select to adjust the gamma curve. (See page 28.)
CONTRAST	±30	Use to adjust the contrast of the projected image. (See page 27.)
BRIGHTNESS	±30	Use to adjust the brightness of the projected image. (See page 27.)
COLOR TEMP.	5 options	Use to adjust the color temperature. (See page 28.)
COLOR	±10	Use to adjust the color thickness of the projected image. (See page 27.)
TINT	±10	Use to adjust the color tint of the projected image. (See page 27.)
SHARPNESS	±5	Use to adjust the sharpness of the projected image. (See page 27.)
BrilliantColor™	0 - 10	Use to adjust the BrilliantColor™ function.
SCREEN SIZE	2 options	Select according to the screen size.
VERTICAL LOCATION	±26	Use to adjust the position (height) of the projected image.

- BrilliantColor™ uses BrilliantColor™ technology of Texas Instruments in USA. When you set this item to other than 0, the projector displays higher resolution images while reproducing superior colors.
- By using the AV memory function, you can save up to 3 setting patterns of IMAGE menu for each input terminal. (See page 26.)

2. INSTALLATION menu

ITEM	SETTING	FUNCTION
LAMP MODE	STANDARD LOW	Select this option when you want to view images in a well-lit room. Select to moderate the intensity of the lamp. The fan operating sound is reduced and the lamp lifetime becomes longer.
LAMP TIME (LOW)	****H	This item shows a lamp operating time (hour) when LAMP MODE is LOW. <ul style="list-style-type: none"> When the LAMP MODE is STANDARD, this item shows a longer lamp operating time than the actual time. (See page 31 for the interval of lamp replacement.)
AUTO POWER ON	ON / OFF	When ON is chosen, the lamp is automatically lit when the power cord is plugged in the wall outlet. Choose ON when using the projector mounted on the ceiling. <ul style="list-style-type: none"> The projector is in the stand-by mode when the lamp is off. Use the remote control to turn on the lamp.
AUTO POWER OFF	OFF / 5 - 60min	Use to set the time elapsed before the projector enters the stand-by mode when there is no signal input from the source.
SPLASH SCREEN	ON / OFF	Choose ON to display the splash screen when the power is turned on.
BACK COLOR	BLUE / BLACK	Use to change the color of the screen that appears when no signal is supplied.
IMAGE REVERSE	OFF	Select when viewing images from the front with the projector installed on the floor.
	MIRROR	Select when viewing images projected from the behind of the screen with the projector installed on the floor.
	INVERT	Select when viewing images projected from the behind of the screen with the projector installed on the ceiling.
	MIRROR INVERT	Select when viewing images from the front with the projector installed on the ceiling.
TRIGGER OUT	ON / OFF	Choose ON to output the trigger output signal (12 V) from the TRIGGER terminal when the lamp illuminates.
TEST PATTERN	CROSS HATCH 	Select to show the test cross hatch pattern. <ul style="list-style-type: none"> When LAMP MODE has been set to LOW, the lamp mode changes from STANDARD to LOW about one minute after turn-on. When the lamp mode is switched, the projected image may flicker. This is not a product malfunction. Do not change the setting of LAMP MODE frequently. To cancel the test pattern, press any button.

3. FEATURE menu

ITEM	SETTING	FUNCTION
ASPECT	AUTO 4:3 16:9 ZOOM1 ZOOM2 STRETCH REAL	Select to change the aspect ratio automatically depending on the input signal. Select to project images with an aspect ratio of 4:3. Select to project images with an aspect ratio of 16:9. (Linearly stretched.) Select to enlarge and project images of CinemaScope size. Select to enlarge and project images of Vista size. Select to enlarge to 16:9 and project of the images with an aspect ratio of 4:3. (Non-linearly stretched.) Select to project images in their original size as input. Not available when the keystone adjustment is applied.
PASSWORD FUNCTION		Use to enable or cancel the password lock. See page 30 for details.
MENU POSITION	2 options	Use to change the position of the menu.
CINEMA MODE	AUTO OFF	The film mode will be automatically activated when a film source signal is input. The film mode will not be activated.
VIDEO SIGNAL	8 options	When AUTO is selected, the appropriate video format is automatically selected depending on the input signal. If the image isn't displayed correctly, select the desired video format manually.
SET UP	AUTO OFF 3.75% / 7.5%	Select AUTO for normal use. When LANGUAGE is not set to 日本語 and 480i, 480p or TV60 signal is input, the SET UP changes to 7.5% automatically. Select to make black lighter. Select to make black intense. <ul style="list-style-type: none"> When 7.5% is chosen, the brightness is decreased by the set-up cancel function for the U.S. Choose OFF when the image is dark.
SCART INPUT	ON / OFF	Choose ON when connecting the projector with a device equipped with the SCART terminal that can output RGB signal. SCART terminal is used mainly in Europe. Choose OFF normally. (Available only for the input signal from the COMPUTER IN/COMPONENT VIDEO IN terminal.)
LANGUAGE	10 languages	Use to select the language used in the menus.
RESET ALL	OK 	Use to reset the settings of the menu (excluding PASSWORD FUNCTION and LANGUAGE) to the factory setting values.

- When SCART INPUT is set to ON, normal computer signals aren't projected.
- Use a SCART-BNC (or SCART-Mini D-SUB 15P) cable (option) when connecting this projector with an AV device equipped with the SCART terminal.
- Some AV devices equipped with the SCART terminal aren't compatible with this projector.
- It may take a little while to carry out RESET ALL in the FEATURE menu.

Menu operation (continued)

4. SIGNAL menu

SVGA60		
SIGNAL	AV MEMORY 1	
HORIZ. POSITION	◀ 0 ▶	
VERT. POSITION	◀ 0 ▶	
FINE SYNC.	◀ 0 ▶	
TRACKING	◀ 0 ▶	
COMPUTER INPUT	◀ AUTO ▶	
OVER SCAN	◀ 100% ▶	
HOLD	◀ ON [ON] ▶	
USER	◀ OK [OK] ▶	

5. USER menu

USER		
CLAMP POSITION	◀ 1 ▶	
CLAMP WIDTH	◀ 1 ▶	
VERT. SYNC	◀ AUTO ▶	
LPF	◀ OFF ▶	
SHUTTER (U)	◀ 0 ▶	
SHUTTER (L)	◀ 0 ▶	
SHUTTER (LS)	◀ 0 ▶	
SHUTTER (RS)	◀ 0 ▶	

4. SIGNAL menu

ITEM	SETTING	FUNCTION
HORIZ. POSITION	0 - 999 *	Use to adjust the horizontal position of the projected image.
VERT. POSITION	0 - 999 *	Use to adjust the vertical position of the projected image.
FINE SYNC.	0 - 31	Use to eliminate flickering or blur, if it appears, while viewing the projected image.
TRACKING	0 - 9999 *	Use to eliminate vertical wide stripes, if it appears, while viewing the projected image.
COMPUTER INPUT	AUTO RGB	The proper setting is automatically selected.
	Y _C B _C R / Y _P B _P R	Select this option when connecting the projector to high definition video equipment having R, G, and B output terminals.
		Select this option when connecting the projector to a DVD player or other device having Y, C _B , and C _R (or Y, P _B , and P _R) component video output terminals.
OVER SCAN	100 - 90% *	Use to adjust the display area of the projected image when playing LD and DVD discs.
HOLD	OFF / ON [ON]	Use to adjust the image when flagging occurs near the top of the screen.

- Options marked with an asterisk (*) become unavailable depending on the type of the input signal.
- Though horizontal strips may appear on the enlarged projected image, such symptom is not a malfunction.
- When you change the horizontal or vertical position to a large extent, noise may appear.
- The adjustable range of the vertical position varies depending on the type of the input signal. Though the image may stay in the same position even when the setting value is changed, such symptom is not a malfunction.
- If you increase the OVER SCAN setting when viewing video signals, noise may appear on the screen. In this case, decrease the OVER SCAN setting.
- When VIDEO or S-VIDEO is chosen as the source, OVER SCAN is not available with certain signals.
- OVER SCAN is not available in the REAL mode.

5. USER menu

ITEM	SETTING	FUNCTION
CLAMP POSITION	1 - 255 *	Use to correct solid white or solid black in the projected image.
CLAMP WIDTH	1 - 63 *	Use to correct solid black in the projected image.
VERT.SYNC	AUTO / OFF	Use to adjust the image when its motion doesn't run smoothly. Select AUTO for normal use.
LPF	ON / OFF	Use to select whether or not to enable the LPF.
SHUTTER (U)	0 - 32	Use to display the black bar on the top part of the image.
SHUTTER (L)	0 - 32	Use to display the black bar on the bottom part of the image.
SHUTTER (LS)	0 - 95	Use to display the black bar on the left half of the image.
SHUTTER (RS)	0 - 95	Use to display the black bar on the right half of the image.

- Options marked with an asterisk (*) become unavailable depending on the type of the input signal.

AV memory

You can store up to 3 patterns of the image quality setting for each input source.

To store the settings

1. Press an AV MEMORY button (M1, M2 or M3) on the remote control to store the settings.
2. Set the items of the IMAGE menu.
 - The settings are automatically stored.
 - Setting the items by using the picture quality adjusting buttons on the remote control is also available.

To enable the stored image quality settings

1. Press the AV MEMORY button to enable the stored setting.
 - The image quality settings stored in the selected memory is enabled.
- When the input source is changed, the AV memory setting selected just before is automatically selected.
- When RESET ALL in the FEATURE menu is selected, all the settings of the AV memory are cleared.

Adjusting projected images

To adjust the brightness (CONTRAST and BRIGHTNESS):

You can make adjustments for the brightness of the projected image using the menu.

(See page 24 for menu setting.)

1. Display the IMAGE menu.
2. Select CONTRAST or BRIGHTNESS by pressing the ▲ or ▼ button.
3. Adjust the selected item by pressing the ◀ or ▶ button.

To cancel the menu:

4. Press the MENU button.

CONTRAST

Select to adjust the contrast of the image. Every time the ▶ button is pressed, the image becomes brighter and more defined. Every time the ◀ button is pressed, the image becomes darker and less defined.

BRIGHTNESS

Every time the ▶ button is pressed, the image becomes brighter. Every time the ◀ button is pressed, the image becomes darker.

To adjust the color (COLOR and TINT):

You can adjust the color of the projected image using the menu.

(See page 24 for menu setting.)

1. Display the IMAGE menu.
2. Select COLOR or TINT by pressing the ▲ or ▼ button.
 - COLOR may be unavailable depending on the type of input signal.
 - TINT is available only when the NTSC signal is input.
3. Adjust the selected item by pressing the ◀ or ▶ button.

To cancel the menu:

4. Press the MENU button.

COLOR

Use to adjust the color intensity of the projected image. Every time the ▶ button is pressed, the color intensity increases. Every time the ◀ button is pressed, the color intensity decreases.

TINT

Use to adjust the tint of the projected image. Every time the ▶ button is pressed, the image appears more greenish. Every time the ◀ button is pressed, the image appears more reddish.

To sharpen or soften the projected image (SHARPNESS):

You can adjust the sharpness of the projected image using the menu.

(See page 24 for menu setting.)

1. Display the IMAGE menu.
2. Select SHARPNESS by pressing the ▲ or ▼ button.
3. Adjust the selected item by pressing the ◀ or ▶ button.

To cancel the menu:

4. Press the MENU button.

Adjusting projected images (continued)

To adjust the tone of white (COLOR TEMP.):

You can select a preset color temperature (white tone) using the menu.
(See page 24 for menu setting.)

1. Display the IMAGE menu.
2. Select COLOR TEMP. by pressing the ▲ or ▼ button.
3. Select your desired color temperature by pressing the ◀ or ▶ button.







To cancel the menu:

4. Press the MENU button.

To adjust the tone of white (To customize the color temperature):

To customize (and store) the color temperature to your preference, carry out the following procedure.
(See page 24 for menu setting.)

1. Select COLOR TEMP. in the IMAGE menu.
2. Press the ◀ or ▶ button to select USER .
3. Press the ENTER button.
4. Press the ▲ or ▼ button to select the desired item.
5. Press the ◀ or ▶ button to adjust the selected item.
6. Repeat steps 4 and 5 for optimum adjustment results.

COLOR TEMP.-USER		
 CONTRAST R	◀ 0 ▶	
 CONTRAST G	◀ 0 ▶	
 CONTRAST B	◀ 0 ▶	
 BRIGHTNESS R	◀ 0 ▶	
 BRIGHTNESS G	◀ 0 ▶	
 BRIGHTNESS B	◀ 0 ▶	

To cancel the menu:

7. Press the MENU button.

To enable the stored color temperature:

1. Select USER by pressing the COLOR TEMP button on the remote control.

About color temperature

There are different kinds of white color. Color temperature is a way to show the differences in white. White of which temperature is low appears reddish. When the color temperature rises, white appears bluish. For example, you can change the color temperature using the following procedures.

To rise the color temperature: Increase the CONTRAST B (blue) and decrease the CONTRAST R (red).

To reduce the color temperature: Decrease the CONTRAST B (blue) and increase the CONTRAST R (red).

- If you set all of CONTRAST R, G, and B to negative values, the original brightness of the image can't be obtained even when you maximize CONTRAST in the IMAGE menu.

To adjust the ratio of change in brightness (GAMMA MODE):

You can select a preset gamma mode using the menu.
(See page 24 for menu setting.)



1. Display the IMAGE menu.
2. Select GAMMA MODE by pressing the ▲ or ▼ button.
3. Select your desired gamma mode by pressing the ◀ or ▶ button.

To cancel the menu:

4. Press the MENU button.

To adjust the original ratio of change in brightness (To customize the gamma mode):

To customize (and store) the gamma mode to your preference, carry out the following procedure.
(See page 24 for menu setting.)

1. Select GAMMA MODE in the IMAGE menu.
2. Press the ◀ or ▶ button to select USER1  or USER2 .
3. Press the ENTER button.
4. Press the ▲ or ▼ button to select REFERENCE.
5. Press the ◀ or ▶ button to select basic gamma curve.
 - Generally, select the most preferable gamma curve from the preset gamma curve.
6. Press the ▲ or ▼ button to select the desired item.
 - HIGH : Use to adjust the gradation of the bright scenes.
 - MID : Use to adjust the gradation of the medium brightness scenes.
 - LOW : Use to adjust the gradation of the dark scenes.
7. Press the ◀ or ▶ button to adjust the selected item.
8. Repeat steps 6 and 7 for optimum adjustment results.

GAMMA MODE-USER1		
 REFERENCE	◀ VIDEO ▶	
HIGH	◀ 0 ▶	
MID	◀ 0 ▶	
LOW	◀ 0 ▶	

To cancel the menu:

9. Press the MENU button.

To enable the stored gamma mode:

1. Select USER1 or USER2 by pressing the GAMMA button on the remote control.
 - Change in the brightness may be hard to recognize in some images.

This projector automatically and properly projects video signals supplied from the computer. However, some video signals may not be projected, depending on the type of the computer. In such a case, press the AUTO POSITION button. (See page 22.) When the signal is still not projected properly, adjust the projected image using the SIGNAL menu.

How to adjust the image supplied from the computer using the menu:

Carry out the following procedures according to the symptoms.

Wide strips appear.	Adjust TRACKING in the SIGNAL menu.
The projected image flickers.	
The projected image is blurred.	Adjust FINE SYNC. in the SIGNAL menu.
The projected image is displaced horizontally.	Adjust HORIZ.POSITION in the SIGNAL menu. Every time the ◀ button is pressed, the image moves to the right. Every time the ▶ button is pressed, the image moves to the left.
The projected image is displaced vertically.	Adjust VERT.POSITION in the SIGNAL menu. Every time the ◀ button is pressed, the image moves down. Every time the ▶ button is pressed, the image moves up.
The top part of the image flags.	Change the setting of HOLD in the SIGNAL menu. Select ON <input checked="" type="checkbox"/> , press the ENTER button, and adjust BEGIN or END to minimize the flagging.
A solid black or solid white appears in the image. ...	Adjust CLAMP POSITION or CLAMP WIDTH in the SIGNAL - USER menu.
The motion doesn't run smoothly.	Adjust VERT. SYNC. in the SIGNAL - USER menu. Select AUTO for normal use.
Noise appears on the right or left half of the image. ...	Adjust SHUTTER (LS) or SHUTTER (RS) in the SIGNAL - USER menu.
Noise appears on the top or bottom part of the image.	Adjust SHUTTER (U) or SHUTTER (L) in the SIGNAL - USER menu.

1. Display the SIGNAL menu.
2. Press the ▲ or ▼ button to select an item to adjust.
3. Adjust the selected item by pressing the ◀ or ▶ button.

To cancel the menu:

4. Press the MENU button.
- Do not change the settings of the SIGNAL menu in normal use.

Simple method to adjust the image position

To adjust the horizontal position:

1. Align the left edge of the image with the left side of the screen by adjusting HORIZ.POSITION. Then, align the right edge of the image with the right side of the screen by adjusting TRACKING.
2. Repeat step 1 above to complete the adjustment of the horizontal position.

To adjust the vertical position:

3. Align the upper edge of the image with the upper side of the screen by adjusting VERT.POSITION.

LPF

You can select whether or not to enable the LPF. This item is set to OFF normally.

Vertical or horizontal streak noise may appear on the projected image, depending on the type of the DVD player you use. In such a case, you can reduce such streak noise by enabling the LPF. However, projected images become softened slightly.

1. Display the SIGNAL menu.
2. Press the ▲ or ▼ button to select USER.
3. Press the ENTER button.
4. Press the ▲ or ▼ button to select LPF.
5. Press the ◀ or ▶ button to choose ON or OFF.



To cancel the menu:

6. Press the MENU button.

Advanced features

Password function

This projector is equipped with the password function that is designed for prevention of theft and wrong operation by children and restriction on operation by other than specified users. The password function has two modes as follows.

DISPLAY INPUTWhen the projector is turned on, the startup screen (or splash screen) will appear and stay on the screen until the password is entered. When the password is entered, the startup screen will switch to the regular operation screen.

MENU ACCESS.....All the buttons except for the POWER button on the projector are disabled. (The buttons on the remote control are enabled.) You can use this mode as a measure of prevention of wrong operation by children and restriction on operation by other than specified users.

To enable the password function:

1. Display the FEATURE menu.
2. Press the ▲ or ▼ button to select PASSWORD FUNCTION.
3. Press the ► button to change the mode among DISPLAY INPUT and MENU ACCESS.
 - When the password has already been set, the mode won't be changed. In such cases, press the ENTER button to cancel the password function and try again.
4. Press the ENTER button.
 - The screen for setting the password function will appear.

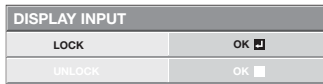

5. Press the ENTER button.
 - The screen for entering a password will appear.

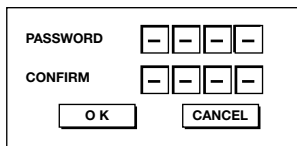

6. Press the ▲ or ▼ button to select a number from 0 to 9.
7. Press the ► button.
 - You can set the next digit.
8. Repeat steps 6 and 7 to set a four-digit password.
9. Enter the password again for confirmation using the same steps.
10. Select OK, and press the ENTER button.
 - If the entered passwords don't match, an error message will appear.
 - To cancel the procedure, select CANCEL and press the ENTER button.
 - You can cancel the procedure by pressing the MENU button alternatively.

To cancel the password function:

1. Display the FEATURE menu.
2. Press the ▲ or ▼ button to select PASSWORD FUNCTION.
3. Press the ENTER button.
 - The screen for canceling the password function will appear.

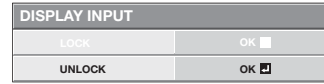

4. Press the ENTER button.
 - The screen for entering the password will appear.

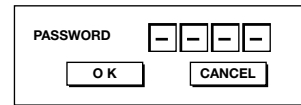

5. Press the ▲ or ▼ button to select a number from 0 to 9.
6. Press the ► button.
 - You can set the next digit.
7. Repeat steps 5 and 6 to enter the four-digit password.
8. Press the ► button, select OK, and press the ENTER button.
 - If you enter a wrong password, an error message will appear.
 - To cancel the procedure, press the ► button, select CANCEL, and press the ENTER button.
 - You can cancel the procedure by pressing the MENU button alternatively.

Important:

- If you forget your password, hold down the MENU and ENTER buttons on the control panel at the same time about three seconds to cancel the password function.

Replacing the lamp

This projector is equipped with a lamp to project images. This lamp is a consumable. It may burn out or its brightness may decrease during use. In such cases, replace the lamp with a new one as soon as possible. Be sure to replace the lamp with a new lamp sold separately that is exclusive to this projector. Contact your dealer for purchase of the lamp.

Warning:

- Be careful not to drop the lamp fixing screws inside of the projector. Don't put a metal piece or flammable object into the projector. Using the projector with any foreign object present inside may result in electric shock or fire. When you can't remove the foreign object from the inside, contact your dealer for removal.
- Be sure to install the lamp securely. When the lamp isn't installed properly, it won't illuminate. Improper installation may also result in fire.
- Don't shake the removed lamp or don't lift it above your face. Your eyes may be injured by flying or falling glass fragments.
- Don't replace the lamp immediately after use because the lamp cover will be very hot. You may get burned. Turn off the power using the POWER button. After the lamp goes out, wait about two minutes until the intake and exhaust fans for cooling the lamp stop rotating. Then unplug the power cord, and wait at least one hour to allow the lamp to cool down enough to the touch.
- Do not touch the lamp directly. It may break and cause injury or burn.

Interval of lamp replacement

The recommended interval of lamp replacement is about 3000 hours^{*1*2} of consecutive use. Such interval differs depending on the operating environment and may be shorter than 3000 hours^{*1*2}. Decrease in luminescence and/or color brightness indicates that the lamp needs to be replaced. When the lamp operation time exceeds 2250 hours^{*1}, the indicator will blink alternately between green and red (while the lamp is lit; when the lamp is not lit, the indicator will be lit red only) and the lamp replacement message will appear on the screen for one minute everytime the lamp is turned on. When the lamp has been used for about 2850 hours^{*1}, the replacement message (LAMP EXCHANGE) will appear on the screen for one minute every 15 hours^{*1} thereafter.

When the lamp operation time exceeds 3000 hours^{*1*2}, the projector automatically shuts off and can't be used until the lamp is replaced and the lamp operation time is reset.

^{*1} Duration when LAMP MODE of the INSTALLATION menu is set to LOW. When it is set to STANDARD, this duration will be shorted.

^{*2} Duration when LAMP MODE is set to STANDARD, this duration will be shorted to 2000 hours.

Caution:

- Don't remove the lamp for any purpose other than replacement. Unnecessary removal of the lamp may result in a breakdown.
- This projector uses a high-pressure mercury lamp as the light source. The high-pressure mercury lamp may explode or fail to illuminate permanently because of an impact, scratch, or deterioration through use. The period of time until explosion or permanent failure to illuminate varies considerably from lamp to lamp, depending on operation conditions. Therefore, the lamp may explode soon after the start of use.
- The possibility of explosion of the lamp increases if you use it beyond its replacement period. When the instruction of lamp replacement appears, replace it with a new one immediately even if the lamp is still lighting normally.
- When the high-pressure mercury lamp explodes, glass fragments will scatter inside or outside the lamp box and the gas charged inside the lamp will diffuse inside or outside the projector. The gas inside the lamp contains mercury. Be careful not to breathe it or avoid it from entering your eye or mouth. If you should breathe it or if it should enter your eye or mouth, see a doctor immediately.
- In the event that the high-pressure mercury lamp exploded, glass fragments may have been scattered inside the projector. Ask your dealer to replace the lamp and to inspect the inside of the projector. When you clean or replace the lamp by yourself, be sure to hold the handle of the lamp. You may get injured by glass fragments.
- Don't replace the lamp while the projector is installed on the ceiling. Glass fragments may fall from the projector, entering your eye or mouth causing injury.
- When placing the projector upside down to replace the lamp or conduct maintenance, ensure that the projector is securely placed before working with it.

Replacing the lamp (continued)

To replace the lamp:

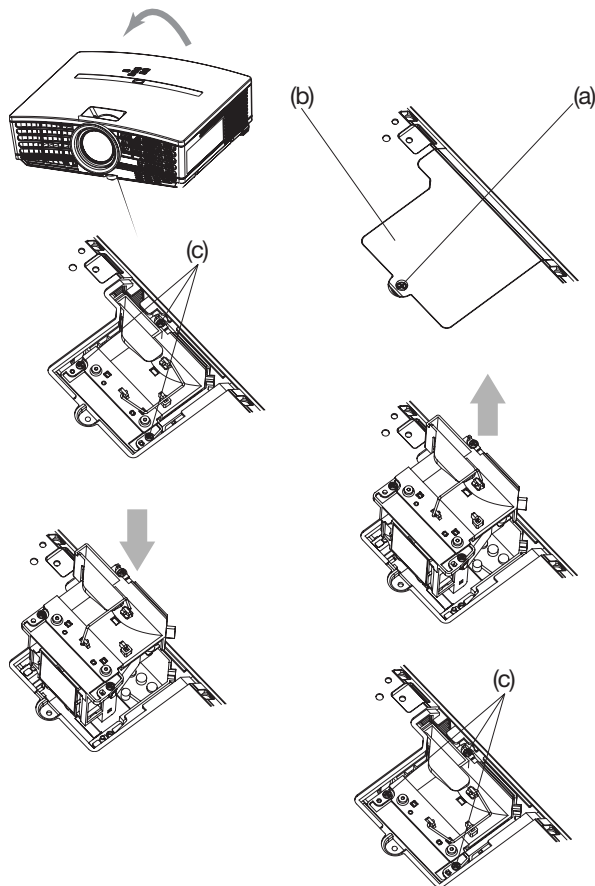

1. Reverse the projector gently.
2. Loosen the screw (a) using a Phillips screwdriver (+), and remove the lamp cover (b).
3. Loosen the screws (c) using a Phillips screwdriver (+).
4. Pull up the handle.
5. Pull out the lamp box by the handle while holding the projector.
 - Pull the lamp box out of the projector slowly. If it is pulled out quickly, the lamp may break scattering glass fragments.
 - Do not spill liquid on the removed lamp box or do not place it near any flammable object or where children can reach to prevent injury or fire.
6. Load a new lamp box securely into the projector in the right orientation.
7. Put the handle back to the original position.
 - Make sure that the handle is locked.
8. Tighten up the screws (c) using a Phillips screwdriver (+).
9. Tighten up the screw (a) using a Phillips screwdriver (+) to secure the lamp cover.

Reset of the lamp operation time

Plug in the power cord and reset the lamp operation time by holding down the ◀, ▶, and POWER buttons on the control panel at the same time about three seconds.

Important:

- Unless these three buttons are pressed at the same time, the lamp operation time isn't reset.
- Make sure that the STATUS indicator blinks twice and the lamp operation time is reset successfully.
- The projector doesn't turn on if the lamp cover isn't attached securely.
- Be sure to reset the lamp operation time whenever you replace the lamp.
- Do not reset the lamp operation time unless you replace the lamp.
- The lamp is fragile. If it is broken, be careful not to cut yourself with glass fragments.
- Contact your dealer for a new lamp.
- This projector uses a lamp that contains mercury. Disposal of the lamp or the projector with the lamp may be regulated due to environmental considerations. For disposal or recycling information, please contact your local authorities or the Electronic Industries Alliance: www.eiae.org. (For the U.S. only.)

Maintenance

Warning:

Do not use flammable solvents (benzene, thinner, etc.) and flammable aerosols when cleaning the projector body and lens. Flammable substances may ignite causing fire or breakdown while the lamp is illuminating.

Caution:

Be sure to turn off the lamp and unplug the power cord from the wall outlet before you perform any maintenance on the projector.

Cleaning of the projector and the ventilation slots

Use a soft cloth to clean the projector and the ventilation grilles. When the grilles become dirty, wipe them with a soft cloth dampened with diluted mild detergent, and then wipe them with a dry cloth.

To protect the surface of the projector from fading or deteriorating:

- Do not spray insecticide on or inside the projector.
- Do not use benzene or thinner to clean it.
- Do not let rubber or plastic materials contact with projector.

Cleaning of the lens

Use a standard lens-cleaning brush or a piece of lens tissue dampened with lens cleaning fluid. The lens surface is fragile. Use only recommended, nonabrasive lens-cleaning materials. Do not touch the lens with your fingers.

Troubleshooting

Before asking for repair of the projector, check the following. If the symptom persists, stop using the projector, be sure to unplug the power plug, and then contact your dealer.

No image appears on the screen.

Problem	Solution																				
Power can not be turned on.	<ul style="list-style-type: none"> Check whether the indicators are on or off and how they are lighting. <table border="1"> <thead> <tr> <th>POWER</th> <th>STATUS</th> <th>Solution</th> </tr> </thead> <tbody> <tr> <td> Off</td> <td> Off</td> <td> <ul style="list-style-type: none"> Connect the power cord to the projector. Plug the power cord into a wall outlet. </td> </tr> <tr> <td rowspan="4"> Steady red</td> <td> Off</td> <td> <ul style="list-style-type: none"> If any objects are blocking the air inlet or outlet grill, remove them and carry out the following. <ol style="list-style-type: none"> Unplug the power cord from the wall outlet. Make sure that the projector has cooled off. Plug the power cord into the wall outlet. Press the POWER button. </td> </tr> <tr> <td> Blinking orange</td> <td> <ul style="list-style-type: none"> If any objects are blocking the air inlet or outlet grille, remove them. Don't expose the air outlet grilles to hot air emitted from a heating appliance. </td> </tr> <tr> <td> Blinking green</td> <td> <ul style="list-style-type: none"> After the STATUS indicator stops blinking, press the POWER button. <ul style="list-style-type: none"> If you unplug the power cord while the fan is rotating, the lamp may not turn on about one minute when you plug the power cord next time. The lamp can't turn on again for one minute after it goes out. Press the POWER button several times. </td> </tr> <tr> <td> Steady red</td> <td> <ul style="list-style-type: none"> Replace the lamp. (The lamp is at the end of its life.) </td> </tr> <tr> <td rowspan="2"> Blinking red / green</td> <td> Off</td> <td> <ul style="list-style-type: none"> Attach the lamp cover on the bottom. </td> </tr> <tr> <td> Steady or Blinking</td> <td> <ul style="list-style-type: none"> Unplug the power cord from the wall outlet and contact your dealer. </td> </tr> </tbody> </table>	POWER	STATUS	Solution	Off	Off	<ul style="list-style-type: none"> Connect the power cord to the projector. Plug the power cord into a wall outlet. 	Steady red	Off	<ul style="list-style-type: none"> If any objects are blocking the air inlet or outlet grill, remove them and carry out the following. <ol style="list-style-type: none"> Unplug the power cord from the wall outlet. Make sure that the projector has cooled off. Plug the power cord into the wall outlet. Press the POWER button. 	Blinking orange	<ul style="list-style-type: none"> If any objects are blocking the air inlet or outlet grille, remove them. Don't expose the air outlet grilles to hot air emitted from a heating appliance. 	Blinking green	<ul style="list-style-type: none"> After the STATUS indicator stops blinking, press the POWER button. <ul style="list-style-type: none"> If you unplug the power cord while the fan is rotating, the lamp may not turn on about one minute when you plug the power cord next time. The lamp can't turn on again for one minute after it goes out. Press the POWER button several times. 	Steady red	<ul style="list-style-type: none"> Replace the lamp. (The lamp is at the end of its life.) 	Blinking red / green	Off	<ul style="list-style-type: none"> Attach the lamp cover on the bottom. 	Steady or Blinking	<ul style="list-style-type: none"> Unplug the power cord from the wall outlet and contact your dealer.
POWER	STATUS	Solution																			
Off	Off	<ul style="list-style-type: none"> Connect the power cord to the projector. Plug the power cord into a wall outlet. 																			
Steady red	Off	<ul style="list-style-type: none"> If any objects are blocking the air inlet or outlet grill, remove them and carry out the following. <ol style="list-style-type: none"> Unplug the power cord from the wall outlet. Make sure that the projector has cooled off. Plug the power cord into the wall outlet. Press the POWER button. 																			
	Blinking orange	<ul style="list-style-type: none"> If any objects are blocking the air inlet or outlet grille, remove them. Don't expose the air outlet grilles to hot air emitted from a heating appliance. 																			
	Blinking green	<ul style="list-style-type: none"> After the STATUS indicator stops blinking, press the POWER button. <ul style="list-style-type: none"> If you unplug the power cord while the fan is rotating, the lamp may not turn on about one minute when you plug the power cord next time. The lamp can't turn on again for one minute after it goes out. Press the POWER button several times. 																			
	Steady red	<ul style="list-style-type: none"> Replace the lamp. (The lamp is at the end of its life.) 																			
Blinking red / green	Off	<ul style="list-style-type: none"> Attach the lamp cover on the bottom. 																			
	Steady or Blinking	<ul style="list-style-type: none"> Unplug the power cord from the wall outlet and contact your dealer. 																			
No image appears on the screen.	<ul style="list-style-type: none"> Check that the lens cap is removed. It may take about one minute for the lamp to light up. The lamp fails to light up on rare occasions. In such a case, wait for a few minutes and then try again. If the projector was turned off before the lamp was cooled down sufficiently last time, the fan may start rotating and the POWER button may not work after the power cord is plugged. After the fan stops rotating, press the POWER button to turn back on the POWER indicator. Check that the intake vent is clean. Set SCART INPUT in the FEATURE menu to OFF. (See page 25.) Check that the lamp cover is closed. (See page 32.) Check that the cables connected to the external devices are not broken. When an extension cable is being used, replace it with the supplied cable for check. When images are displayed correctly, add an RGB signal amplifier to the extension cable. Check the operation manual of the video device for its connection. 																				
Projected images suddenly disappear.	<ul style="list-style-type: none"> This problem may occur when the intake vent and/or exhaust vents are blocked. (In such a case, the STATUS indicator blinks orange.) <ul style="list-style-type: none"> Remove the objects blocking the intake vent and/or exhaust vents and then carry out the following procedure. <ol style="list-style-type: none"> Wait for the intake fan and/or exhaust fan to stop. (Wait until the STATUS indicator goes out.) Unplug the power cord from the wall outlet. Wait about 10 minutes. Plug the power cord into the wall outlet. Press the POWER button. When the STATUS indicator is steady red, it is indicating that the lamp should be replaced. Replace the lamp in this case. 																				
The screen for entering the password appears.	<ul style="list-style-type: none"> PASSWORD FUNCTION in the FEATURE menu has been set to DISPLAY INPUT to enable the password lock. <ul style="list-style-type: none"> Enter the password or contact the person in charge of management of the projector. (See page 30.) 																				

Troubleshooting (continued)

No image appears on the screen. (continued)

Problem	Solution
“NO SIGNAL” is displayed.	<ul style="list-style-type: none"> • Turn on the power of the connected device, or check whether there is something wrong with the connected device. • Check whether the external device output signals. (Check this especially when the external device is a notebook computer.) • Check that the cable connected to the external device isn't defective. • Check that the projector is connected to the external device using the correct terminals. • Check that the connected device is correctly selected as the input source. • When an extension cord is being used, replace it with the supplied cable and check whether images are projected correctly. If images are projected correctly, use an RGB signal amplifier along with the extension cord.

Images are not displayed correctly.

Problem	Solution
Projected images are shaking. Projected images are displaced.	<ul style="list-style-type: none"> • Check that the cable connected to the external device isn't intermittent. • Connect the cable's plug with the external device's connector firmly. • Press the AUTO POSITION button. • Some computers output out-of-spec signals on rare occasion. Adjust the SIGNAL menu. (See page 29.)
Projected images are distorted.	<ul style="list-style-type: none"> • Adjust the projector and the screen so that they are perpendicular to each other. (See page 10.)
Projected images are dark.	<ul style="list-style-type: none"> • Adjust BRIGHTNESS and CONTRAST in the IMAGE menu. (See page 27.) • Replace the lamp. (See page 31.)
Projected images are blurred.	<ul style="list-style-type: none"> • Adjust the focus. (See pages 17 and 21.) • Clean the lens. • Press the ◀ or ▶ button on the remote control to eliminate flicker. • Adjust TRACKING and FINE SYNC. in the SIGNAL menu. (See page 29.) • Adjust BRIGHTNESS and CONTRAST in the IMAGE menu. (See page 27.) • Adjust the projector and the screen so that they are perpendicular to each other. (See page 10.)
White dots are seen on projected images. Black dots are seen on projected images.	<ul style="list-style-type: none"> • This symptom is normal for a DLP™ projector and is not a malfunction. (A very small number of pixels may stay lit or out, but such symptom is not a malfunction. Pixels of 99.99% or more are effective.)
Rainbow effect is seen on projected images.	<ul style="list-style-type: none"> • This is due to color breaking noise that occurs in a DLP™ system and is not a malfunction.
Fine streaks are seen on projected images.	<ul style="list-style-type: none"> • This is due to interference with the screen surface and is not a malfunction. Replace the screen or displace the focus a little.
Projected images become wavy.	<ul style="list-style-type: none"> • Connect the plugs of the cables to external devices securely. • Keep the projector away from devices that emit interfering radio waves. • When the keystone adjustment is carried out, the image may not be displayed correctly depending on the type of input signal. This isn't a product malfunction. In this case, readjust the keystone so that the amount of keystone correction is as small as possible.
Hue is not appropriate.	<ul style="list-style-type: none"> • Check that the cables connected to the external devices are not broken.
Tint in projected images is incorrect.	<ul style="list-style-type: none"> • Check that COMPUTER INPUT in the SIGNAL menu is correctly set. (See page 26.) • Check that the cable connected to the external device isn't broken.
Only the motion areas in the images supplied from the computer aren't displayed.	<ul style="list-style-type: none"> • This is caused by the computer being used. Contact the manufacturer of your computer.
Projected images are obscured.	<ul style="list-style-type: none"> • Match the output resolution of your computer with the resolution of the projector. For the method to change the output resolution of the computer, contact the manufacturer of your computer. (See page 38.) • Some images and texts appear obscured during the keystone adjustment. In such cases, use the projector without applying the keystone adjustment. (See page 18.)

Others

Problem	Solution
The exhaust vents emit warm air.	<ul style="list-style-type: none"> This air comes out after cooling the inside of the projector. You may feel hot, but this is not a malfunction.
The menu can't be used.	<ul style="list-style-type: none"> The microcomputers inside the projector may be wrongly operating because of noise. <ul style="list-style-type: none"> → Press the POWER button to turn off the lamp and unplug the power cord from the wall outlet. Wait about 10 minutes, plug the power cord in, and try again.
"TEMPERATURE!!" is displayed.	<ul style="list-style-type: none"> This indication appears when the ambient temperature rises high. When the ambient temperature stays high, the lamp goes out. <ul style="list-style-type: none"> → Eliminate any causes of the rise in the ambient temperature. This indication appears when the air inlet or outlet grille is blocked. When they are kept blocked, the lamp goes out. <ul style="list-style-type: none"> → Remove the objects blocking the air inlet or outlet grille. Clean the filter, if clogged.
The  mark appears.	<ul style="list-style-type: none"> This mark appears when ineffective operation is carried out. This isn't a product malfunction.
The remote control doesn't function easily or at all.	<ul style="list-style-type: none"> Check that the batteries are loaded in the remote control or the batteries are not weak. (See page 6.) Check that the remote control sensor isn't exposed to direct sunlight or fluorescent light. (See page 9.) Use the remote control within its operation range. (See page 9.) Use the remote control at least 10 cm away from the projector.
The buttons on the control panel (except for the POWER button) don't function.	<ul style="list-style-type: none"> PASSWORD FUNCTION in the FEATURE menu has been set to MENU ACCESS to enable the password lock. <ul style="list-style-type: none"> → Cancel the password lock or contact the person in charge of management of the projector. (See page 30.)
Abnormal sound is heard.	<ul style="list-style-type: none"> Because the color wheel spins at a high speed, metallic sounds may be heard in rare occasions. Such symptom is not a malfunction.

If the following problem occurs after the lamp is replaced, check the following first.

Problem	Solution
The projector does not turn on.	<ul style="list-style-type: none"> Fit the lamp cover securely. (See pages 31 and 32.) Reset the lamp operating time. (See page 32.)
The STATUS indicator blinks.	<ul style="list-style-type: none"> Reset the lamp operating time. (See page 32.)

Kensington Lock

This projector has a Kensington Security Standard connector for use with Kensington MicroSaver Security System. Refer to the information that came with the Kensington System for instructions on how to use it to secure the projector. Please contact Kensington Technology Group below.

Kensington Technology Group
2855 Campus Drive
San Mateo, CA 94403, U.S.A.





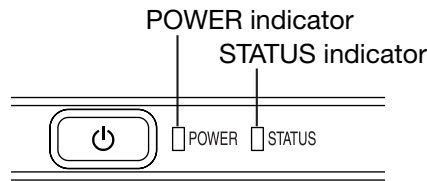

Phone: +1- (650)572-2700 Fax: +1- (650)572-9675

Indicators











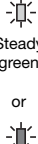

This projector has two indicators, each of which shows the operation condition of the projector. The following offer solutions to possible problems. If these problem persist, turn the projector off and consult your dealer.



Normal condition

POWER	STATUS	CONDITION	NOTE
 Steady red	 Off	Stand-by	
 Steady green	 Blinking green	Lamp stand-by (about 1 minute)	The POWER button cannot be used to switch between on and off.
 Steady green	 Steady green	The power is on. (Normal condition)	

Abnormal condition

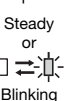
POWER	STATUS	CONDITION	POSSIBLE SOLUTION
 Steady green or Steady red	 Blinking orange	Abnormal temperature <ul style="list-style-type: none"> • The ventilation grilles are clogged with dust or dirt. • The room temperature is high. 	<ul style="list-style-type: none"> • Clean the ventilation grilles. • Relocate the projector to a cooler place.
 Steady red	 Blinking green	The protection circuit is working or the lamp is in an abnormal condition.	<ul style="list-style-type: none"> • Wait until the STATUS indicator goes out, then press the POWER button. • If the above solution is not effective, replace the lamp.
 Steady green	 Blinking green/red	Lamp operation time warning. (Total lamp operation time reached 2250 hours ^{*1} while the power was on.)	Replace the lamp. Change with a new lamp if this problem recurs.
 Steady red	 Blinking red	Lamp operation time warning. (Total lamp operation time reached 2250 hours ^{*1} while the power was off.)	
 Steady red	 Steady red	Lamp operation time warning. (Total lamp operation time reached 3000 hours ^{*1*2} while the power was off.)	
 Blinking green/red	 Off	The lamp cover isn't closed.	Close the cover correctly.
 Blinking green/red	 Steady or Blinking	Abnormal.	Contact your dealer.

*1 Duration when LAMP MODE of the INSTALLATION menu is set to LOW. When it is set to STANDARD, this duration will be shorted.

*2 Duration when LAMP MODE is set to STANDARD, this duration will be shorted up to 2000 hours.

Specifications

The specifications and outside appearance of the projector are subject to change without prior notice.

Type	DLP™ projector		
Model	HD1000		
Display technology	0.62-inch single chip DMD (aspect ratio 16:9) Pixel: 1280 x 720 = 921600 pixels		
Projection lens	F 2.4 - 2.6 f= 23 - 27.6 mm		
Light-source lamp	200 W		
Image size (projection distance)	40" min. to 275" max. (projection distance 1.3 to 10 m)		
Maximum resolution	Computer signal	Maximum resolution: 1280 x 1024 dots (analog)/compressed Panel resolution: 1280 x 720 dots	
	Video signal	NTSC/PAL/SECAM/4.43NTSC/PAL-M/PAL-N/PAL-60	
	Component signal	480i, 480p, 576i, 576p, 720p, 1080i Panel resolution: 1280 x 720 dots	
Computer input	[Signal type]	[Terminal type]	[Line]
	Analog RGB	D-SUB 15P	1
	HDMI	HDMI 19P	1
Video input	[Signal type]	[Terminal type]	[Line]
	Video input	RCA	1
	S-video input	S	1
	Component video input	RCA	1
Control terminal/ others	SERIAL	RS-232C (8-pin)	
	TRIGGER	DC 12 V, max. 200 mA (stereo mini jack)	
Operating temperatures	+41°F (+5°C) to +95°F (+35°C)		
Rated voltage	AC100 - 240 V, 50/60 Hz		
Power consumption	2.9 A		
Dimensions	310 mm (W) x 100 mm (H) x 245 mm (D) * Not including protrusion.		
Weight	2.9 kg		
Others	S-video input	Luminance signal: Vp-p=1.0 V 75 Ω (negative sync) Chrominance signals: Vp-p=0.286 V 75 Ω (burst signal)	
	Video input	Vp-p=1.0 V 75 Ω (negative sync)	
	Component video input	YCbCr: Vp-p=1.0 V 75Ω (Y) (negative sync) Vp-p=0.7 V 75 Ω (Cb, Cr)	
	Analog input	RGB: Vp-p=0.7 V 75 Ω (negative sync) YCbCr: Vp-p=1.0 V (Y) (negative sync) Vp-p=0.7 V (Cb, Cr) HD/CS: TTL-level (negative or positive polarity) VD: TTL-level (negative or positive polarity)	
	Digital input (HDMI)	HDMI interface (TMDS single link)	

Dimension drawings (unit: mm)

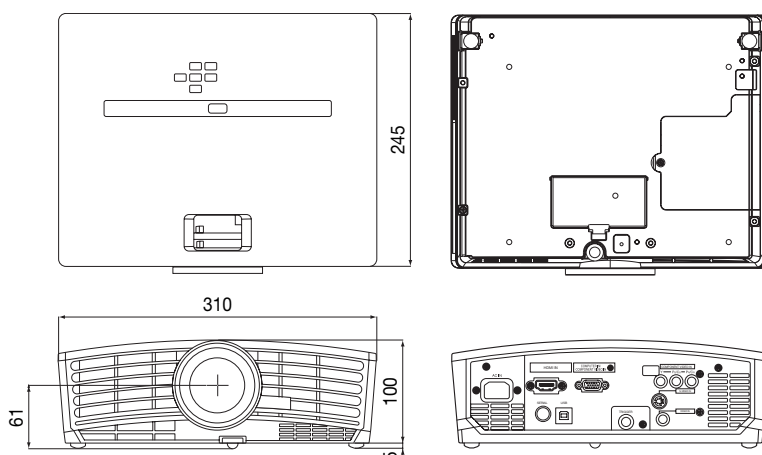

Specifications (continued)

Specification of RGB signals in each computer mode of the projector

Signal mode	Resolution (H x V)	Horizontal frequency (kHz)	Vertical frequency (Hz)	Normal mode (H x V)*1	Real mode (H x V)
TV60, 480i (525i)	—	15.73	59.94	1280 x 720	—
TV50, 576i (625i)	—	15.63	50.00	1280 x 720	—
1080i 60 (1125i 60)	—	33.75	60.00	1280 x 720	—
1080i 50 (1125i 50)	—	28.13	50.00	1280 x 720	—
480p (525p)	—	31.47	59.94	1280 x 720	—
576p (625p)	—	31.25	50.00	1280 x 720	—
720p 60 (750p 60)	—	45.00	60.00	1280 x 720	—
720p 50 (750p 50)	—	37.50	50.00	1280 x 720	—
PC98	640 x 400	24.82	56.42	1152 x 720	640 x 400
CGA70	640 x 400	31.47	70.09	1152 x 720	640 x 400
VGA60	640 x 480	31.47	59.94	960 x 720	640 x 480
VGA72	640 x 480	37.86	72.81	960 x 720	640 x 480
VGA75	640 x 480	37.50	75.00	960 x 720	640 x 480
VGA85	640 x 480	43.27	85.01	960 x 720	640 x 480
SVGA56	800 x 600	35.16	56.25	960 x 720	800 x 600
SVGA60	800 x 600	37.88	60.32	960 x 720	800 x 600
SVGA72	800 x 600	48.08	72.19	960 x 720	800 x 600
SVGA75	800 x 600	46.88	75.00	960 x 720	800 x 600
SVGA85	800 x 600	53.67	85.06	960 x 720	800 x 600
XGA60	1024 x 768	48.36	60.00	960 x 720	—
XGA70	1024 x 768	56.48	70.07	960 x 720	—
XGA75	1024 x 768	60.02	75.03	960 x 720	—
XGA85	1024 x 768	68.68	85.00	960 x 720	—
MAC13	640 x 480	35.00	66.67	960 x 720	640 x 480
MAC16	832 x 624	49.72	74.55	960 x 720	832 x 624
MAC19	1024 x 768	60.24	75.02	960 x 720	—
HP75	1024 x 768	62.94	74.92	960 x 720	—
SXGA60	1280 x 1024	60.02	63.98	900 x 720	—

*1: When ASPECT in the FEATURE menu is set to AUTO and SCREEN SIZE in the IMAGE menu is set to 16:9.

*2: Available for the signal for the HDMI IN terminal.

Important:

- Some computers aren't compatible with the projector.
- The projector's maximum resolution is 1280 x 720 pixels. It may not display images of higher resolutions than 1280 x 720 correctly.
- If the resolution and frequency of your computer aren't shown on the table, find the compatible resolution and frequency by changing the resolution of your computer.
- In the case of XGA, the right side of the image may not appear. In this case, adjust TRACKING in the SIGNAL menu.

- TV60 and TV50 are equivalent to 480i and 576i respectively. When these signals are supplied to the VIDEO IN or S-VIDEO IN terminal, the signal mode is indicated as TV60 or TV50. When they are supplied to the COMPONENT VIDEO IN or COMPUTER IN/COMPONENT VIDEO IN terminals, the signal mode is indicated as 480i or 576i.

- This projector doesn't support video devices having 4 lines (R, G, B, CS*), and 480i, 576i and 480p signals from video devices having 5 lines (R, G, B, H, V).

* : Composite Sync

Connectors

SERIAL (8-pin)

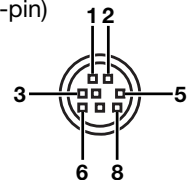

Pin No.	Name	I/O
1	TXD	IN
2	—	—
3	—	—
4	GND	—
5	—	—
6	—	—
7	RXD	OUT
8	—	—

COMPUTER IN/COMPONENT VIDEO IN (Mini D-SUB 15-pin)

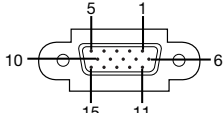

Pin No.	Spec.
1	R(RED)/Cr
2	G(GREEN)/Y
3	B(BLUE)/Cb
4	GND
5	GND
6	GND
7	GND
8	GND
9	DDC 5V
10	GND
11	GND
12	DDC Data
13	HD/CS
14	VD
15	DDC Clock

HDMI IN (HDMI 19-pin)

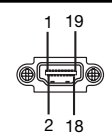

PIN No.	SPEC	PIN No.	SPEC
1	TMDS Data2+	11	TMDS Clock Shield
2	TMDS Data2 Shield	12	TMDS Clock-
3	TMDS Data2-	13	-
4	TMDS Data1+	14	-
5	TMDS Data1 Shield	15	SCL
6	TMDS Data1-	16	SDA
7	TMDS Data0+	17	DDC Ground
8	TMDS Data02 Shield	18	+5 V Power
9	TMDS Data0-	19	Hot Plug Detect
10	TMDS Clock+		

Replacement part (Option/not included in the box)

Spare lamp

VLT-HC910LP

MITSUBISHI Projector Contact Information

North America

MESCA (Mitsubishi Electric Sales Canada Inc.)
<http://www.mitsubishielec.com>
Information Technologies Group, 4299 14th Avenue,
Markham, Ontario L3R 0J2, Canada
Sales & Technical Inquiries
Phone :+1-(800) 450-6487
Fax :+1-(905) 475-7958
E-mail :projectors@mitsubishielec.ca

Customer Care
E-mail :support@mitsubishielec.ca

MDEA (Mitsubishi Digital Electronics America, Inc.)
(Warranty Registration)
<http://www.mitsubishi-presentations.com/>
Presentation Products Division, 9351 Jeronimo Road,
Irvine, CA 92618 U.S.A.

Sales & Inquiries
Phone :+1(888) 307-0349 or +1(949)465-6000
E-mail :ppdinfo@mdea.com

Technical Inquiries
Phone :+1-(888) 307-0309
E-mail :TSUPPORT@mdea.com

Europe

MEU-FRA (Mitsubishi Electric Europe B.V. French Branch)
25, Boulevard des Bouvets 92 741, Nanterre CEDEX,
France
Sales Inquiries
Phone :+33 (0)1 55-68-55-53
Fax :+33 (0)1 55-68-57-31

Technical Inquiries
Phone :+33 (0)1 55-68-56-42
Fax :+33 (0)1 55-68-57-31

MEU-GER (Mitsubishi Electric Europe B.V. German Branch)
<http://www.mitsubishi-evs.de/>
Gothaer Strasse 8, 40880 Ratingen, Germany
Sales Inquiries
Phone :0049 - 2102 - 486 9250
Fax :0049 - 2102 - 486 7320

Technical Inquiries
Phone :0049 - 2102 - 486 1330
Fax :0049 - 2102 - 486 1340

MEU-IR (Mitsubishi Electric Europe B.V. Irish Branch)
<http://www.mitsubishi.ie/>
Westgate Business Park, Ballymount, Dublin 24, Ireland
Sales Inquiries
Phone :+353-1-4198807
Fax :+353-1-4198890

Technical Inquiries
Phone :+353-1-4198808
Fax :+353-1-4198895

MEU-IT (Mitsubishi Electric Europe B.V. Italian Branch)
Centro Direzionale Colleoni, Palazzo Sirio, Viale Colleoni 7,
20041 Agrate Brianza, Italy
Sales & Technical Inquiries
Phone :+39-(0)39-60531
Fax :+39-(0)39-6053214
E-mail :info.projector@it.mee.com

MEU-NL (Mitsubishi Electric Europe B.V. Benelux Branch)
<http://www.mitsubishi.nl/LCD/ProdFrame.html>
Nijverheidsweg 23A, 3641 RP Mijdrecht, The Netherlands
Sales Inquiries
Phone :+31-297-282461
Fax :+31-297-283936
E-mail :info@mitsubishi.nl

Technical Inquiries
Phone :+31-297-282461
Fax :+31-297-283936
E-mail :info@mitsubishi.nl

Russia (Mitsubishi Electric Europe B.V. Moscow
Representative Office)
<http://www.mitsubishi-projector.ru/>
Moscow Representative Office, 52/5 Kosmodamianskaya
Nab., 115054, Moscow, Russia
Sales & Technical Inquiries
Phone :+(7095) 721-2068
Fax :+(7095) 721-2071

MEU-SP (Mitsubishi Electric Europe B.V. Spanish Branch)
<http://www.mitsubishielec.com>
Ctra. de Rubi, 76-80, 08173 Sant Cugat del Valles,
Barcelona, Spain
Sales Inquiries
Phone :+34-93.565.31.54
Fax :+34-93.589.43.88
E-mail :mitsubishi.profesional@sp.mee.com

Technical Inquiries
Phone :+34-93.586.27.51
Fax :+34-93.588.53.87
E-mail :mitsubishi.profesional@sp.mee.com

MEU-SWE (Mitsubishi Electric Europe B.V. Scandinavian
Branch)
Hammarbacken 14, Box 750, S-19127, Sollentuna, Sweden
Sales Inquiries
Phone :+46-(0)8-6251070
Fax :+46-(0)8-6251036

Technical Inquiries
Phone :+46-(0)8-6251052
Fax :+46-(0)8-6251036

MEU-UK (Mitsubishi Electric Europe)
<http://www.mitsubishi.co.uk/evs/>
Visual Information Systems Division, Travellers Lane,
Hatfield, Hertfordshire, AL10 8XB U.K.
Sales Inquiries
Phone :+44 (1707) 278684
Fax :+44 (1707) 278541
E-mail :projector.info@meuk.mee.com

Technical Inquiries
Phone :+44 (870) 606 5008
Fax :+44 (1506) 431927
E-mail :projector.info@meuk.mee.com

Asia

CHINA (Mitsubishi Electric Air-Conditioning & Visual
Information Systems (Shanghai) Ltd.)
26/F., Oriental Center, 699 Nanjing Rd(W), Shanghai,
200041, China
Sales Inquiries
Phone :+86(21) 5211-0882-3002
Fax :+86(21) 5211-0576

Technical Inquiries
Phone :+86(21) 5211-0882-3020
Fax :+86(21) 5211-0576

HONG KONG (Mitsubishi Electric Ryoden Air-Conditioning
& Visual Information Systems (HongKong) Ltd.)
7th Floor, Manulife Tower, 169 Electric Road, North Point,
Hong Kong
Sales Inquiries
Phone :+852-2510-1505
Fax :+852-2510-0463

Technical Inquiries
Phone :+852-2422-0161
Fax :+852-2487-0181

SINGAPORE (Mitsubishi Electric Asia Pte. Ltd.)
<http://www.mitsubishielec.com.sg>
307, Alexandra Road, #05-01/02 Mitsubishi Electric
Building, Singapore 159943
Sales Inquiries
Phone :+65-6473-2308
Fax :+65-6475-9503
E-mail :Peripherals@asia.meap.com

Technical Inquiries
Phone :+65-6470-2666
Fax :+65-6475-9503

INDIA (Mitsubishi Electric Asia Pte. Ltd.)
307, Alexandra Road, #05-01/02 Mitsubishi Electric
Building, Singapore 159943
Sales Inquiries
Phone :+65-6473-2308
Fax :+65-6475-9503
E-mail :Peripherals@asia.meap.com

Technical Inquiries
Phone :+65-6470-2666
Fax :+65-6475-9503

INDONESIA (Mitsubishi Electric Asia Pte. Ltd.)
307, Alexandra Road, #05-01/02 Mitsubishi Electric
Building, Singapore 159943
Sales Inquiries
Phone :+65-6473-2308
Fax :+65-6475-9503
E-mail :Peripherals@asia.meap.com

Technical Inquiries
Phone :+65-6470-2666
Fax :+65-6475-9503

PHILIPPINES (Mitsubishi Electric Asia Pte. Ltd.)
<http://www.mitsubishielec.com.sg>
307, Alexandra Road, #05-01/02 Mitsubishi Electric
Building, Singapore 159943
Sales Inquiries
Phone :+65-6473-2308
Fax :+65-6475-9503
E-mail :Peripherals@asia.meap.com

Technical Inquiries
Phone :+65-6470-2666
Fax :+65-6475-9503

VIETNAM (Mitsubishi Electric Asia Pte. Ltd.)
307, Alexandra Road, #05-01/02 Mitsubishi Electric
Building, Singapore 159943
Sales Inquiries
Phone :+65-6473-2308
Fax :+65-6475-9503
E-mail :Peripherals@asia.meap.com

Technical Inquiries
Phone :+65-6470-2666
Fax :+65-6475-9503

STC (Setsuyo Astec Corporation Seoul Branch)
4F, Dongseo Game Channel Bldg, 660-11 Deungchon-Dong,
Kangseo-Ku, Seoul, Korea
Sales & Technical Inquiries
Phone :+82-(0)2-2657-9841~3
Fax :+82-(0)2-2657-9900

MALAYSIA (Antah Melco Sales & Services Sdn. Bhd.)
6, Jalan 13/6 46860 Petaling Jaya Selangor, Darul Ehsan,
Malaysia
Sales & Technical Inquiries
Phone :+60-(0)3-79552088 (Ext. 203)
Fax :+60-(0)3-79563950/+60-(0)3-79582576

Technical & Service Inquiries
Phone :+60-(0)3-79552088 (Ext. 106)
Fax :+60-(0)3-79563950/+60-(0)3-79582576

ME-TWN (Mitsubishi Electric Taiwan Co., Ltd.)
<http://www.MitsubishiElectric.com.tw>
11TH FL., 90 SEC. 6, CHUNG SHAN N. RD., TAIPEI, 111
R.O.C.
Sales & Technical Inquiries
Phone :+886-2-2832-8255
Fax :+886-2-2833-9813

MKY (Mitsubishi Electric Kang Yong Watana Co., Ltd.)
<http://www.mitsubishi-kyw.co.th/>
Road, Huamark Bangkokpi, Bangkok 10240, Thailand
Sales & Technical Inquiries
Phone :+66-2-731-6841
Fax :+66-2-379-4763

Oceania

ME-AUST (Mitsubishi Electric Australia)
<http://www.mitsubishi-electric.com.au/prod.asp?prod=proj>
348 Victoria Road, Rydalmere, N.S.W. 2116, Australia Sales
& Technical Inquiries
Phone :+(612)9684-7777
Fax :+(612)9684-7208
E-mail :diamonddigital@meaust.meap.com

Technical Inquiries
Phone :+(612)9684-7694
Fax :+(612)9684-7684
E-mail :service@meaust.meap.com

BDT (Black Diamond Technologies Ltd.)
(Warranty Registration) <http://www.bdt.co.nz/projectors/warranty.asp>
1 Parliament St, Lower Hutt, Wellington, New Zealand Sales
Inquiries
Phone :+64-(0)4-560-9100
Fax :+64-(0)4-560-9133
E-mail :projectorsales@bdt.co.nz

Technical Inquiries
Phone :+64-(0)4-560-9100
Fax :+64-(0)4-560-9133
E-mail :service@bdt.co.nz